



# VULCAN SOUTH

## Erosion and Sediment Control Plan

Prepared for Vitrinite Pty Ltd owner of Qld Coal Aust No. 1 Pty Ltd and Queensland Coking Coal Pty Ltd

15 November 2024

1571-35-C2

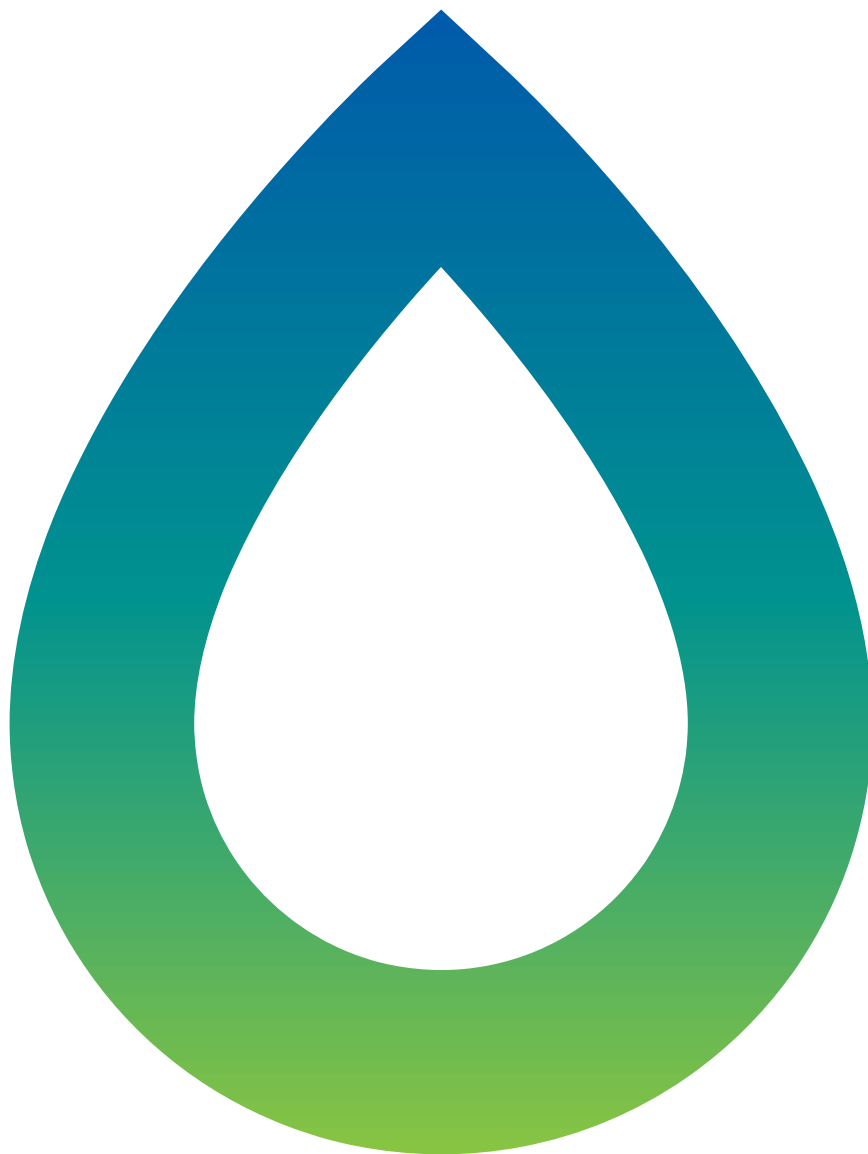

---

## DETAILS

<b>Report Title</b>	Vulcan South, Erosion and Sediment Control Plan
<b>Client</b>	Prepared for Vitrinite Pty Ltd owner of Qld Coal Aust No. 1 Pty Ltd and Queensland Coking Coal Pty Ltd

---

## THIS REVISION

<b>Report Number</b>	1571-35-C2
<b>Date</b>	15 November 2024
<b>Author</b>	PP/RN
<b>Reviewer</b>	JO

---

NOTE: This report has been prepared on the assumption that all information, data and reports provided to us by our client, on behalf of our client, or by third parties (e.g. government agencies) is complete and accurate and on the basis that such other assumptions we have identified (whether or not those assumptions have been identified in this advice) are correct. You must inform us if any of the assumptions are not complete or accurate. We retain ownership of all copyright in this report. Except where you obtain our prior written consent, this report may only be used by our client for the purpose for which it has been provided by us.

---

## TABLE OF CONTENTS

1	INTRODUCTION	8
1.1	BACKGROUND	8
1.2	DESCRIPTION OF OPERATIONS	8
1.3	REGULATORY REQUIREMENTS	8
1.4	PURPOSE AND SCOPE	8
1.5	REFERENCE DOCUMENTS	9
1.6	REPORT STRUCTURE	9
2	ESC FRAMEWORK	23
2.1	REGULATORY FRAMEWORK AND RELEVANT GUIDELINES	23
2.2	PROJECT SPECIFIC STATUTORY DOCUMENTS	23
2.3	STRATEGIC APPROACH	23
2.4	RESPONSIBILITIES AND ACCOUNTABILITIES	23
2.5	REEF DISCHARGE STANDARDS FOR INDUSTRIAL ACTIVITIES	24
3	EXISTING ENVIRONMENT	25
3.1	REGIONAL DRAINAGE NETWORK	25
3.2	LOCAL DRAINAGE NETWORK	26
3.2.1	Drainage line 1 and 2	26
3.2.2	Drainage line 6	27
3.2.3	Drainage line 7	27
3.2.4	Hughes Creek	29
3.2.5	Drainage line 8	29
3.3	TOPOGRAPHY	34
3.4	SOIL CHARACTERISTICS	34
3.4.1	Soil management units	34
3.4.2	Sodic and dispersive soils	35
3.5	ENVIRONMENTAL VALUES	35
4	EROSION AND SEDIMENT CONTROL	38
4.1	OVERVIEW	38
4.2	PRINCIPLES OF ESC	38
4.3	POTENTIAL SOURCES OF EROSION	39
4.4	EROSION POTENTIAL	40
4.4.1	Soils	41
4.4.2	Slope	41
4.4.3	Area and duration	41
4.4.4	Location within the localised catchments	42
4.4.5	Waterways	42
5	EROSION CONTROL MEASURES	43
5.1	OVERVIEW	43

5.2	EROSION CONTROL TECHNIQUES	43
5.2.1	Control of erosion on slopes	43
5.2.2	Soil stabilisation and protection	43
6	DRAINAGE CONTROL MEASURES	45
6.1	OVERVIEW	45
6.2	PERMANENT DRAINAGE	45
6.3	OPERATIONAL DRAINAGE CONTROLS	45
6.3.1	Design standards	45
6.3.2	Drainage design techniques	46
6.3.3	Drain velocity control structures	47
6.3.4	Channel linings	48
6.3.5	Outlet structures	49
6.3.6	Drainage control on unsealed roads	50
6.3.7	Watercourse crossings	51
6.3.8	Typical configurations – Windrow	52
6.3.9	Typical drain configurations - Channel	53
7	SEDIMENT CONTROL MEASURES	55
7.1	OVERVIEW	55
7.2	SEDIMENT CONTROL TECHNIQUES	55
7.2.1	Primary controls	55
7.2.2	Supplementary sediment control techniques	56
8	ESC PLAN	57
8.1	ESC DECISION PROCESS	57
8.2	ESC CRITERIA	57
8.3	ESC HAZARD ASSESSMENT	58
8.4	ESC MATRIX	58
8.5	INSTALLATION SEQUENCE	58
8.6	MAINTENANCE REQUIREMENTS	63
8.7	ESC INVENTORY REGISTER	63
9	MONITORING AND EMERGENCY REPORTING	64
9.1	OVERVIEW	64
9.2	MONITORING AND ESC SCHEDULE	65
9.3	SURFACE WATER	67
9.3.1	Water quantity	67
9.3.2	Release to receiving waters	67
9.3.3	Water quality	67
9.4	MAINTENANCE AND INSPECTIONS	70
9.4.1	ESC structures and clean water drains	70
9.4.2	Levee monitoring	71
9.4.3	Drainage line diversion monitoring	72
9.5	EMERGENCY RESPONSE	72
9.5.1	Overview	72



9.5.2 Uncontrolled releases	73
9.6 DAM MONITORING	73
9.7 WET WEATHER ACCESS	73
9.8 POST-EVENT MONITORING	73
9.9 AUDIT SCHEDULE	73
10 REFERENCES	77
EROSION HAZARD ASSESSMENT (IECA, 2008)	
DRAIN AND SEDIMENT DAM SIZING	
SITE-SPECIFIC ESC INSPECTION TEMPLATE	

---

## FIGURES

Figure 1.1	Project location	10
Figure 1.2	VS North, VS Main, VS South	11
Figure 1.3	Stage 1 (Year 2024) VS North mining area conceptual drainage plan	12
Figure 1.4	Stage 1 (Year 2024) VS Main mining area conceptual drainage plan	13
Figure 1.5	Stage 2 VS North mining area conceptual drainage plan	14
Figure 1.6	Stage 2 VS Main mining area conceptual drainage plan	15
Figure 1.7	Stage 3 VS Main mining area conceptual drainage plan	16
Figure 1.8	Stage 3 VS South mining area conceptual drainage plan	17
Figure 1.9	VS Highwall western and middle bench mining area conceptual drainage plan	18
Figure 1.10	VS Highwall eastern bench mining area conceptual drainage plan	19
Figure 1.11	VS North final landform (post-closure) conceptual drainage plan	20
Figure 1.12	VS Main final landform (post-closure) conceptual drainage plan	21
Figure 1.13	VS South final landform (post-closure) conceptual drainage plan	22
Figure 3.1	Photograph of Drainage line 6 passing under Norwich Park Branch railway	27
Figure 3.2	Photograph of Drainage line 7 south of the Vulcan North mining area	28
Figure 3.3	Photograph of Drainage line 7 passing through box culverts under Saraji Road	28
Figure 3.4	Photograph of Hughes Creek passing under Saraji Road	29
Figure 3.5	Regional catchments in the vicinity of the project	30
Figure 3.6	Local drainage features – northern project area	31
Figure 3.7	Local drainage features – central project area	32
Figure 3.8	Local drainage features – southern project area	33
Figure 3.9	Percentage slope across the project area	36
Figure 3.10	Isaac River Sub-Basin EVs (source: DES, 2013)	37

Figure 6.1	Typical rock check dam configuration (IECA, 2008)	48
Figure 6.2	Typical rock placement in a chute (IECA, 2008)	49
Figure 6.3	Typical level spreader configuration (IECA, 2008)	50
Figure 6.4	Typical energy dissipater configuration (IECA, 2008)	50
Figure 6.5	Typical temporary culvert crossing in a minor stream with low-gradient overbanks (IECA, 2008)	52
Figure 6.6	Typical temporary culvert crossing in a constricted channel with steep overbanks (IECA, 2008)	52
Figure 6.7	Upslope diverted water configuration – diversion bank (IECA, 2008)	53
Figure 6.8	Typical drainage configuration - channel (IECA, 2008)	54
Figure 7.1	Typical type D sediment basin cross-section (Source: IECA, 2008)	55
Figure 9.1	Vulcan South surface water monitoring locations – northern project area	74
Figure 9.2	Vulcan South surface water monitoring locations – southern project area	75
Figure 9.3	Surface water monitoring, investigation and management flowchart	76
Figure 0.1	Example ESC inspection template	

---

## TABLES

Table 3.1	Soil Management Units surveyed on site	34
Table 4.1	Potential erosion and sediment sources	39
Table 4.2	Definition of slope class	41
Table 5.1	Erosion control measures on slopes	43
Table 5.2	Summary of erosion control techniques	44
Table 6.1	Drainage design standards for temporary drainage works	46
Table 6.2	Allowable flow velocities for open earth lined drains	46
Table 6.3	Velocity control structures for channels and drains	47
Table 6.4	Scour protection and lining types for channels	48
Table 6.5	Scour protection for channel and drain outlets	49
Table 7.1	Summary of supplementary sediment control techniques	56
Table 8.1	ESC hazard assessment for land uses at the Project	60
Table 8.2	ESC Matrix	62
Table 9.1	Surface water monitoring locations (Table F2 of EA)	64
Table 9.2	Mine affected water storages (Table F4 of the EA)	65
Table 9.3	ESC structure schedule	66
Table 9.4	ESC structure monitoring locations (Table F1 of the EA)	68

<b>Table 9.5</b>	<b>Contaminant trigger investigation levels (from Table F3 of the EA)</b>	<b>69</b>
<b>Table 0.1</b>	<b>Indicative diversion drain sizing</b>	
<b>Table 0.2</b>	<b>Sediment dam sizing</b>	

---

## **1 INTRODUCTION**

### **1.1 BACKGROUND**

Vulcan South (the Project), which is managed by Vitrinite Pty. Ltd., is a proposed open pit and highwall mining operation located to the southeast of Moranbah, in Central Queensland. The Project is located immediately south and west of Vitrinite’s initial mining project, the Vulcan Coal Mine (VCM), located on ML700060.

The location of the project is shown in Figure 1.1. Figure 1.2 shows an overview of the Project area including the Highwall trial mining area in the northwest, the Vulcan North mining area in the north, the Vulcan Main mining area in the Project centre and the Vulcan South mining area in the south. The proposed mine stage layouts for the Project, including all major surface water infrastructure elements required during operations and post-mining, are shown in Figure 1.3 to Figure 1.13.

### **1.2 DESCRIPTION OF OPERATIONS**

The major components of the Project include:

- three open cut pits (Vulcan North, Vulcan Main and Vulcan South) and a highwall trial mining area (Vulcan Highwall Mining);
- access and haul roads;
- runoff drains and bunds;
- ex-pit dumps;
- Mine infrastructure area (MIA) (including admin area, bathhouse and workshops);
- Run of Mine (ROM) pad and crushing and screening plant;
- erosion and sediment control structures; and
- mine water management structures.

The project involves three stages of mining – Stage 1, Stage 2 and Stage 3. The location of the open cut pits and highwall trial mining area is presented in Figure 1.2. The conceptual drainage plan for the mining areas for each stage is presented in Figure 1.3 to Figure 1.10. Figure 1.11 to Figure 1.13 shows the VS post closure drainage plan.

### **1.3 REGULATORY REQUIREMENTS**

This ESC plan has been prepared to meet the requirements of the Model Mine Conditions (DES, 2017) and Conditions F29 and F30 of the Environmental Authority P-EA-100265081 (the EA) for VS.

### **1.4 PURPOSE AND SCOPE**

Surface water at the project site is categorised into four types, as discussed in the Vulcan South Water Management Plan (which is currently being prepared):

- ‘Diverted’ – surface runoff from areas where water quality is unaffected by mining operations. Diverted water includes runoff from undisturbed areas and any fully rehabilitated areas;
- ‘Surface’ – surface runoff water from areas that are disturbed by mining operations (including out-of-pit overburden dumps and haul roads);
- ‘Mine affected’ – surface water that has come in contact with operational areas such as in the pit and the industrial area; and
- ‘External water’ - external water is water sourced external to the mining operation.

The primary purpose of this document is to develop strategies to manage two types of surface water (diverted water and surface water) at the project site. The management strategies for mine affected and external water are described elsewhere in the Vulcan South Water Management Plan (once completed). With respect to diverted and surface water, this ESC Plan attempts to:

- examine and address all issues relevant to the generation, management, and mitigation of erosion and sediment transport at the Project;
- provide guidance in erosion and sediment related issues and management techniques applicable to the Project;
- determine the appropriate requirements for sediment and erosion control and management for all land uses at the Project; and
- comply with relevant environmental licences and other regulatory requirements.

The benefits of establishing an ESC Plan include:

- minimise off-site impacts (by-products of erosion);
- deliver stable landforms that will not pollute downstream environments;
- provide clear, concise and standardised practices for operations;
- provide clarity for planners, supervisors and contractors; and
- improve auditability and conformance to standards.

## 1.5 REFERENCE DOCUMENTS

This ESC plan forms part of the water management system for the Project and is to be read in conjunction with the Vulcan South Water Management Plan (once completed).

This ESC plan references the document prepared by the International Erosion Control Association (IECA) entitled *Best Practice Erosion and Sediment Control Guidelines (2008)*.

## 1.6 REPORT STRUCTURE

This report is structured as follows:

- Section 2 describes the ESC framework including regulatory requirements, environmental values and water quality objectives;
- Section 3 describes the existing environment including expected soil characteristics;
- Section 4 outlines the principles of erosion and sediment control;
- Section 5 provides a description of erosion control measures;
- Section 6 provides a description of drainage control measures;
- Section 7 provides a description of sediment control measures;
- Section 8 outlines the development of ESC plans;
- Section 9 presents the requirements for monitoring, maintenance and reporting on ESC measures; and
- Section 10 gives a list of references.

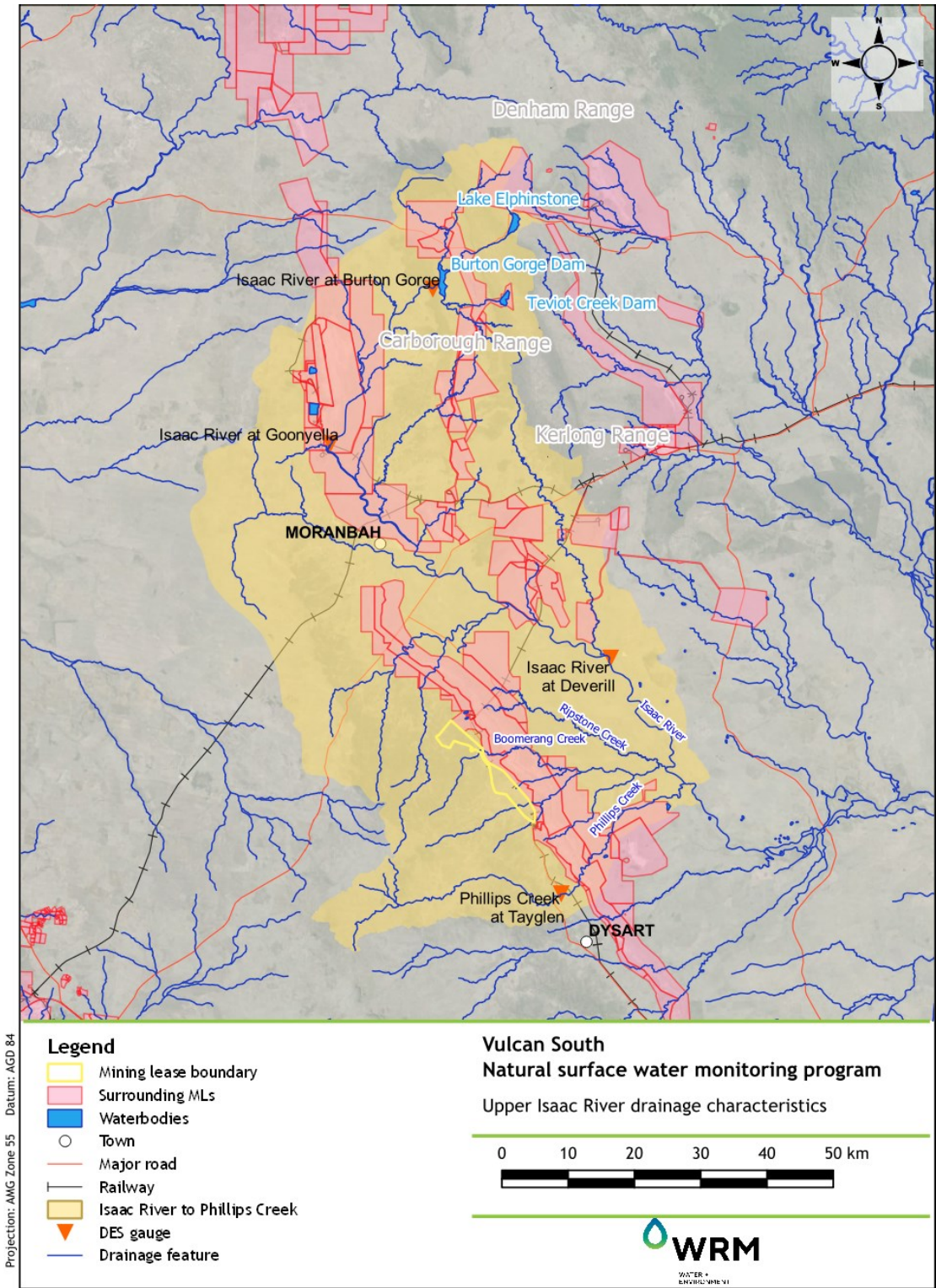

Figure 1.1 Project location



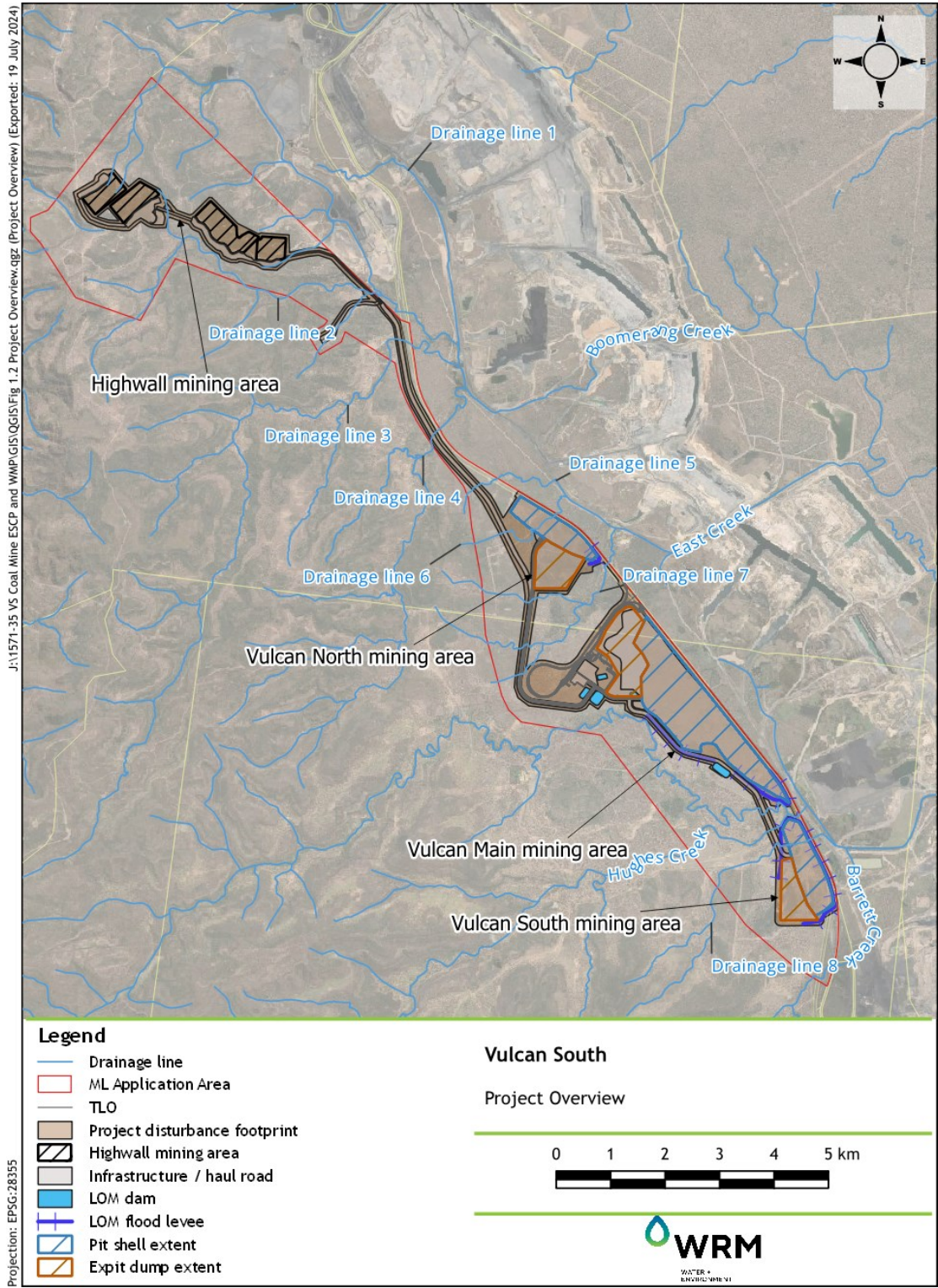

Figure 1.2 VS North, VS Main, VS South



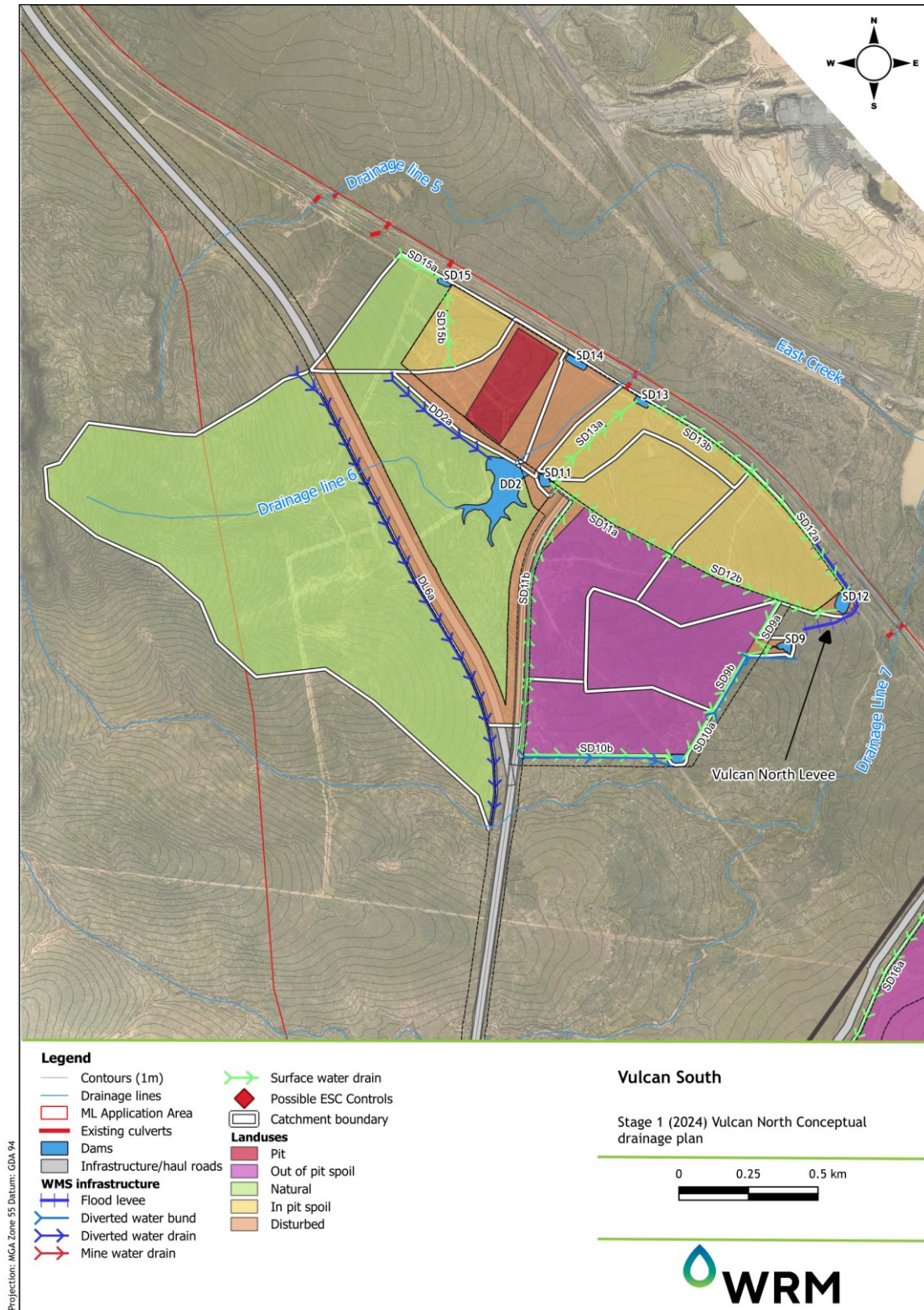

Figure 1.3 Stage 1 (Year 2024) VS North mining area conceptual drainage plan



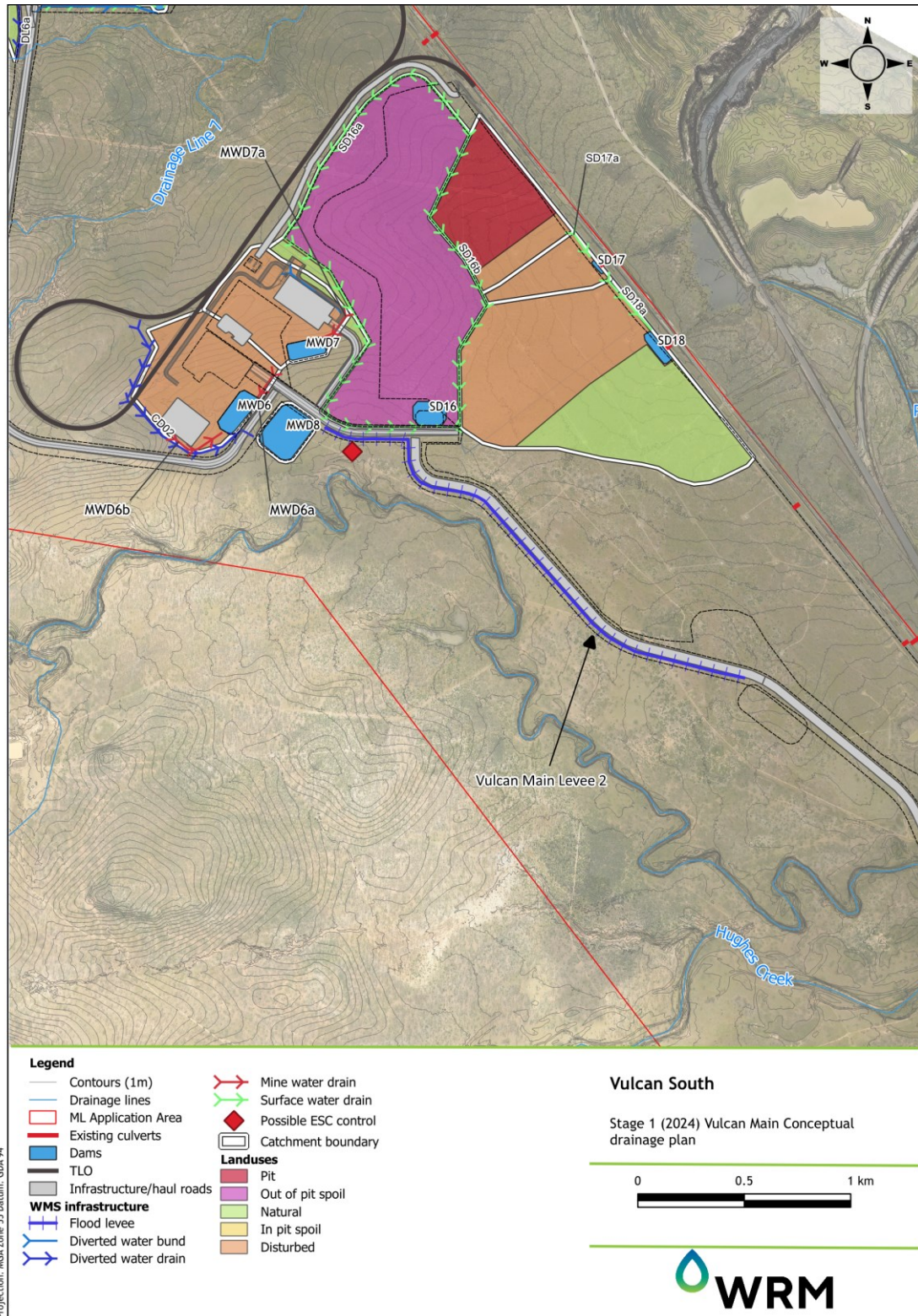

Figure 1.4 Stage 1 (Year 2024) VS Main mining area conceptual drainage plan



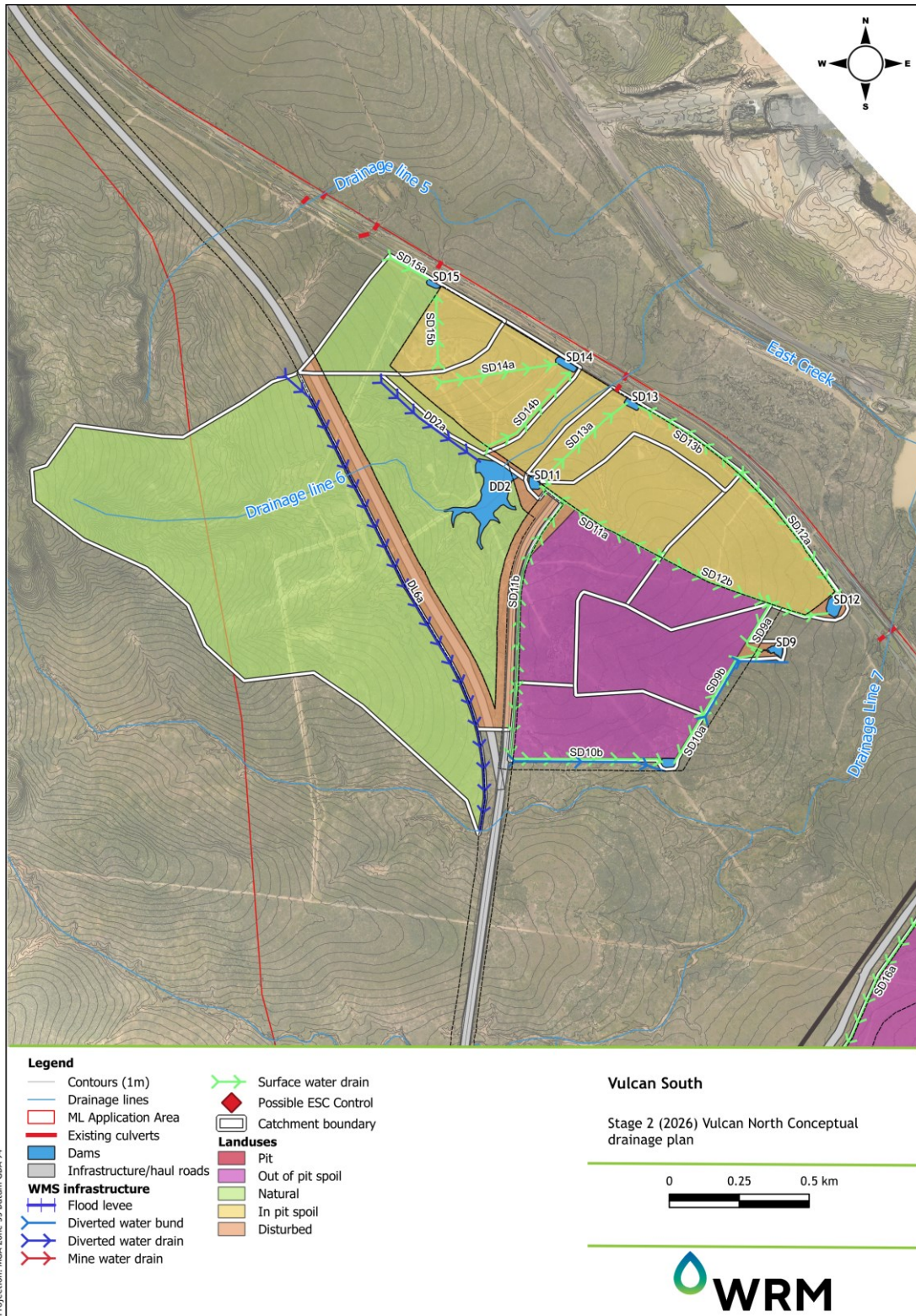

Figure 1.5 Stage 2 VS North mining area conceptual drainage plan



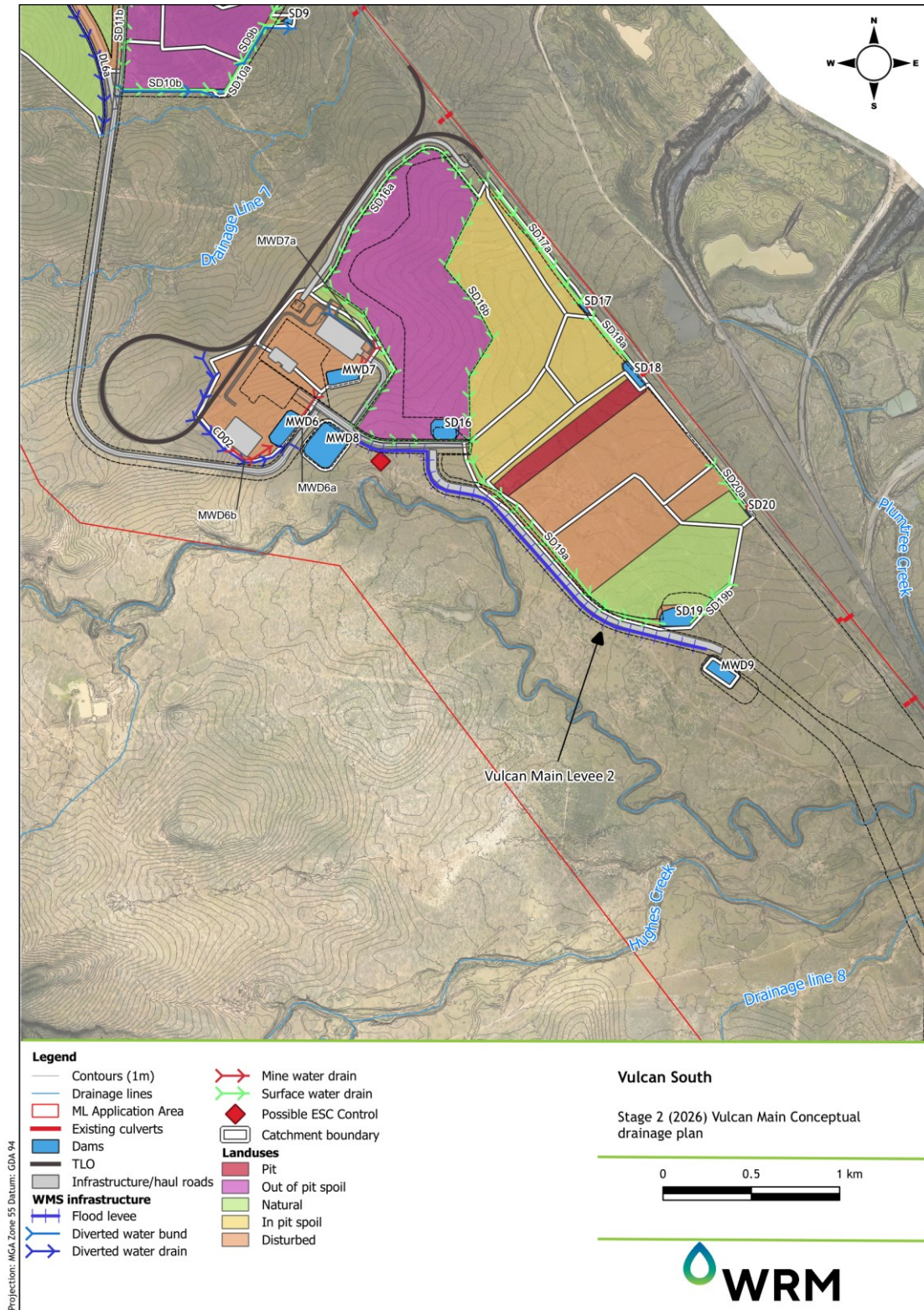

Figure 1.6 Stage 2 VS Main mining area conceptual drainage plan



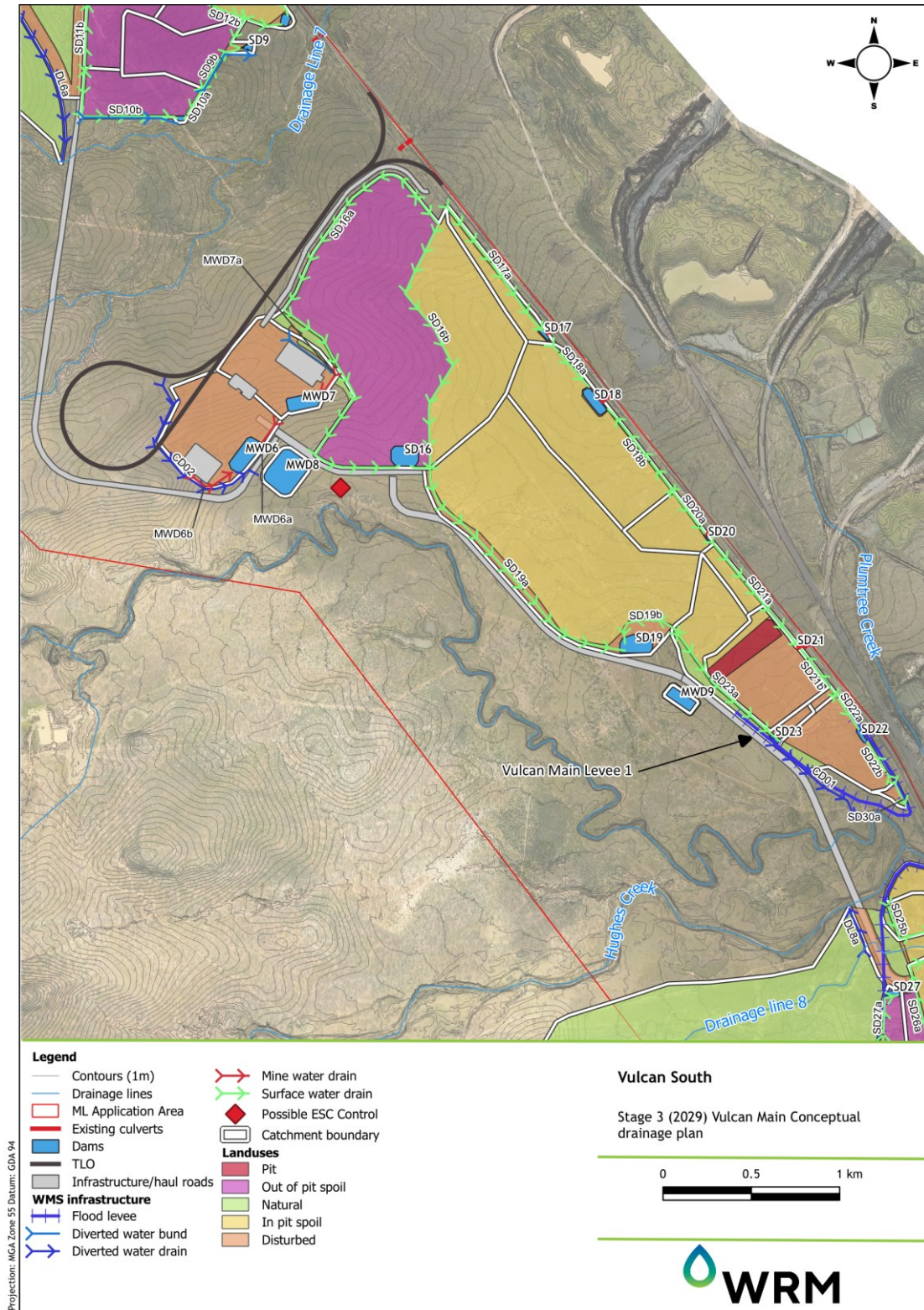

Figure 1.7 Stage 3 VS Main mining area conceptual drainage plan



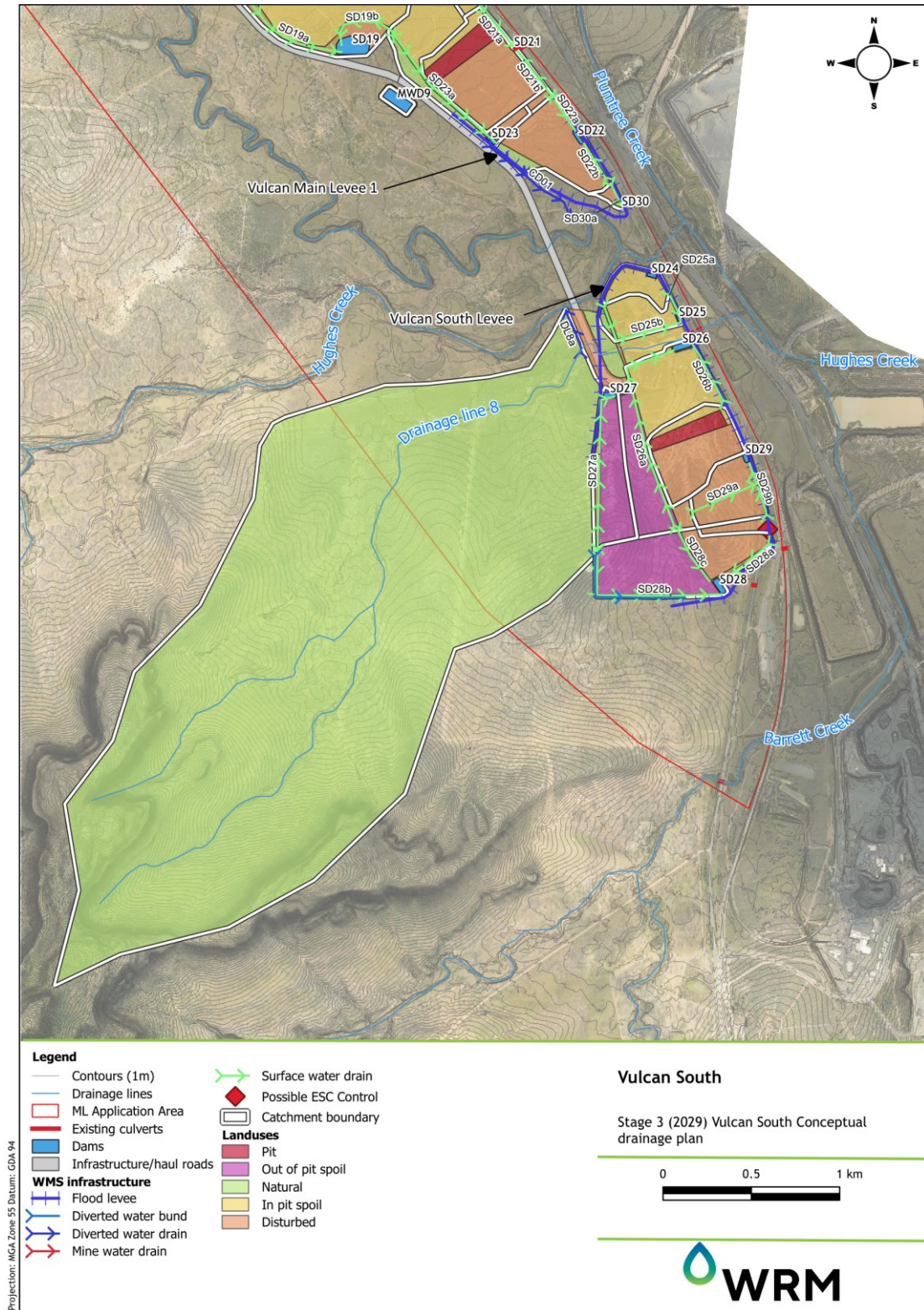

Figure 1.8 Stage 3 VS South mining area conceptual drainage plan







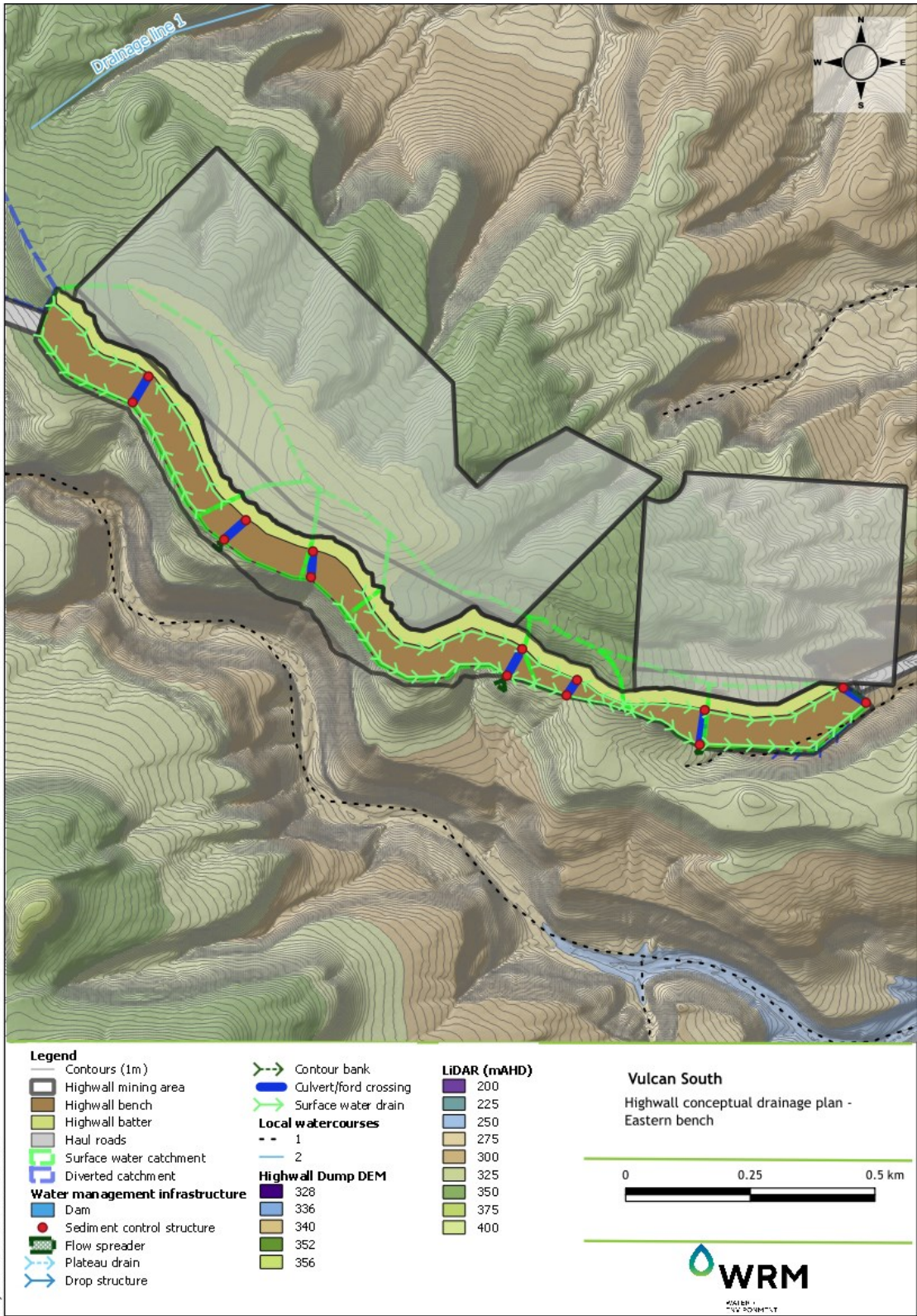

Figure 1.10 VS Highwall eastern bench mining area conceptual drainage plan



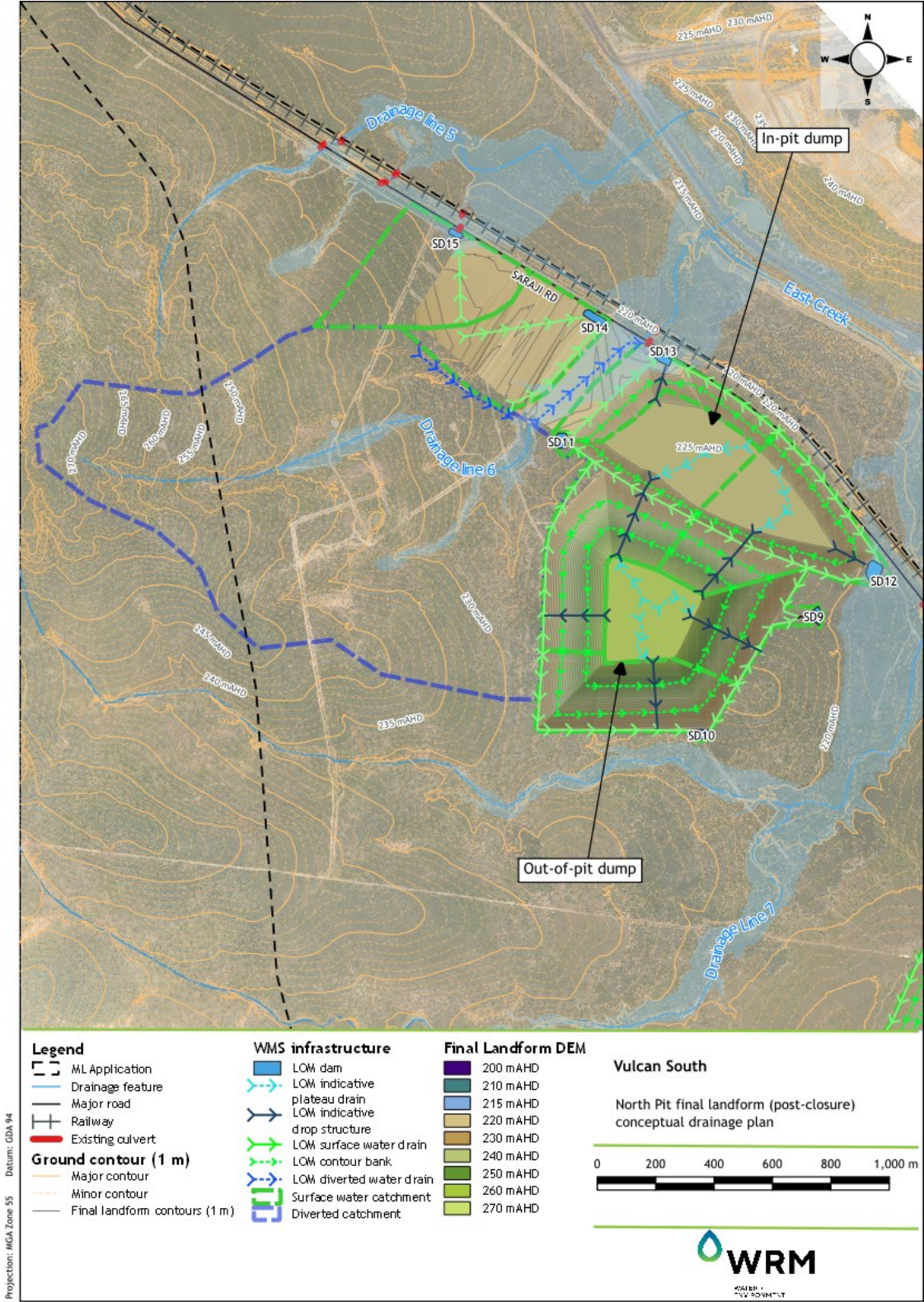

Figure 1.11 VS North final landform (post-closure) conceptual drainage plan



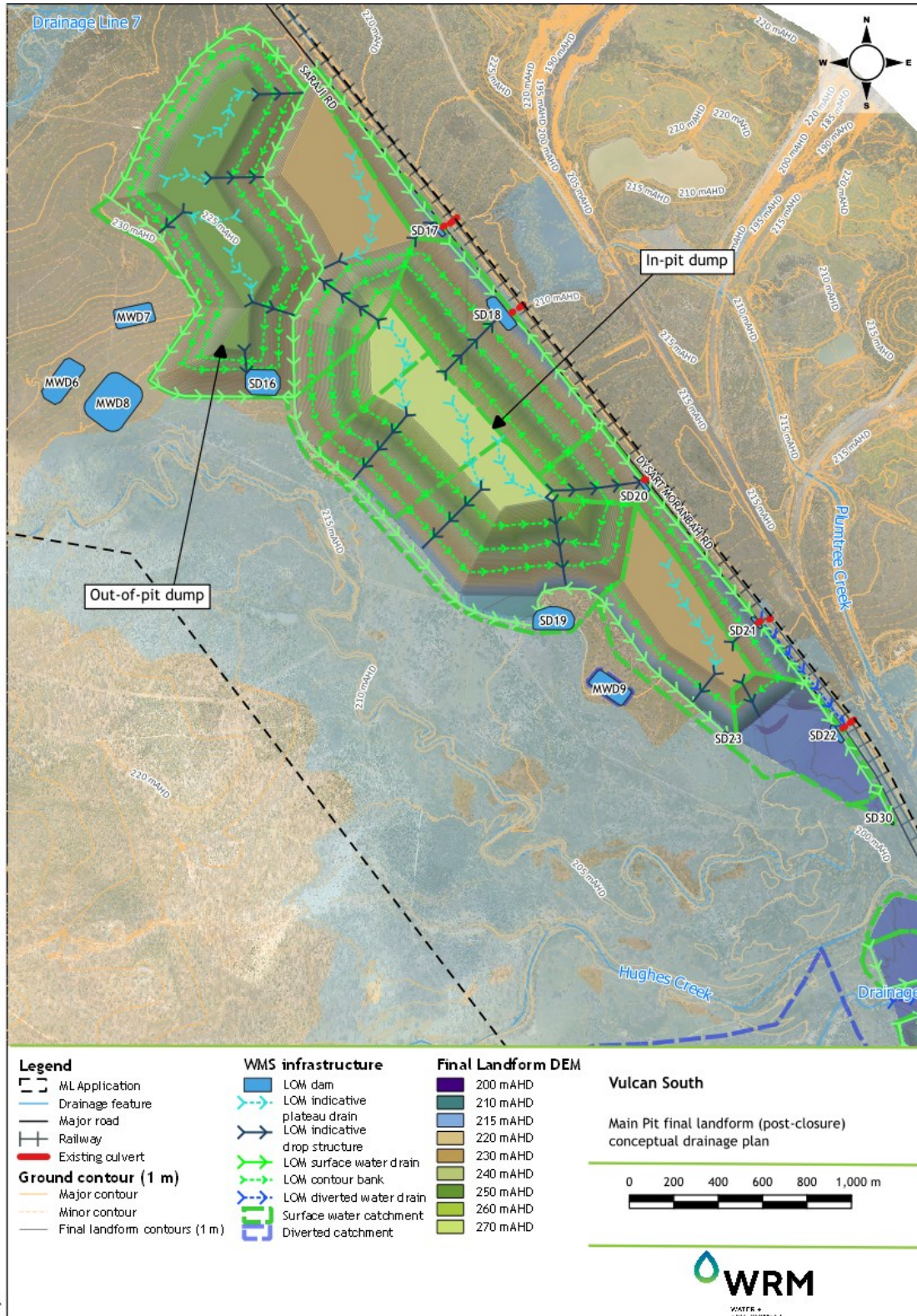

Figure 1.12 VS Main final landform (post-closure) conceptual drainage plan



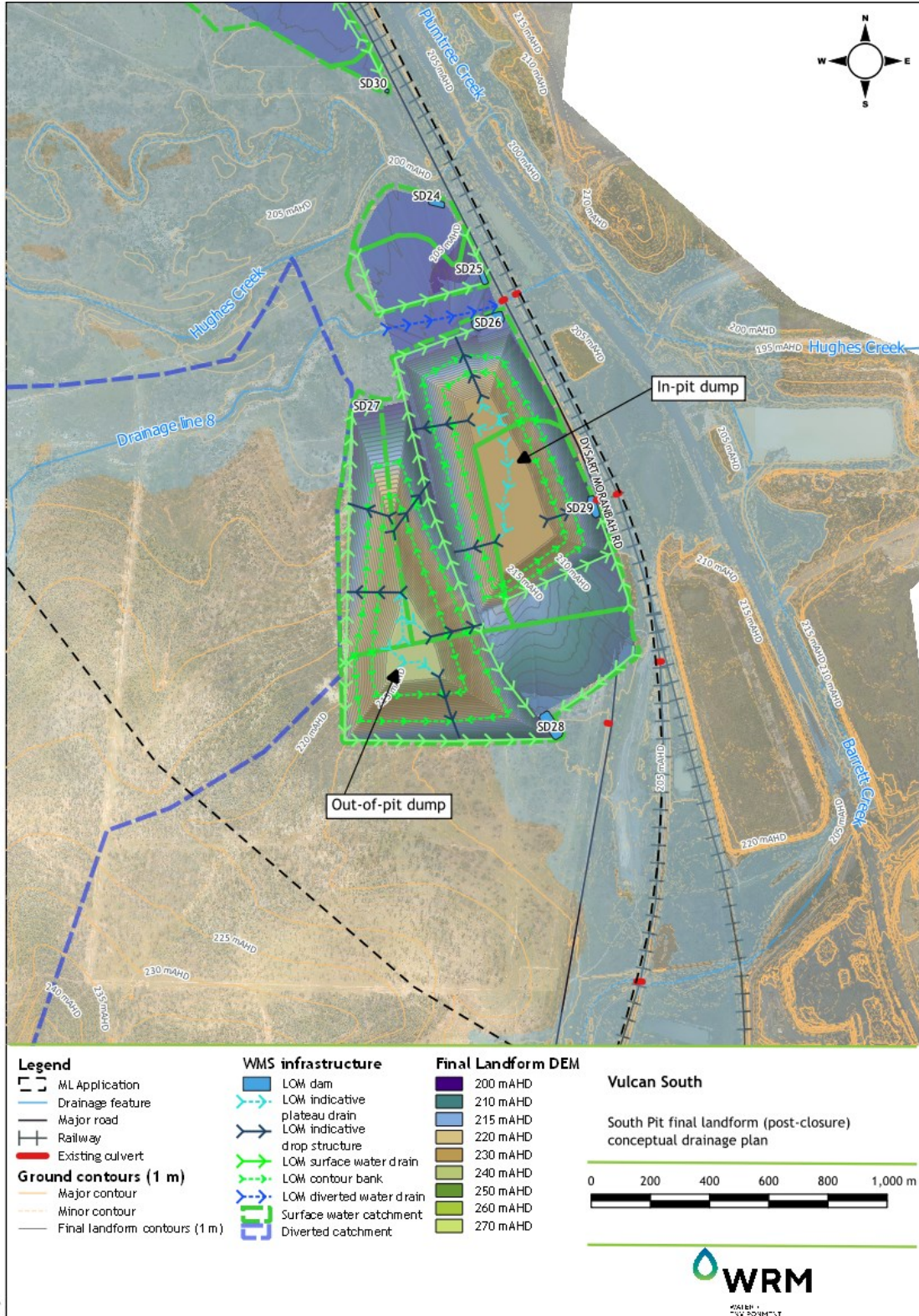

Figure 1.13 VS South final landform (post-closure) conceptual drainage plan

---

## **2 ESC FRAMEWORK**

### **2.1 REGULATORY FRAMEWORK AND RELEVANT GUIDELINES**

The following regulatory framework and relevant guidelines are applicable to the ESC plan for the Project:

- Environmental Protection Act (EPA) 1994 and Environmental Protection (Water and Wetland Biodiversity) Policy 2019 (EPP Water, 2019);
- Queensland Water Quality Guidelines 2009 (DEHP, 2013);
- Model water conditions for coal mines in the Fitzroy basin (DES, 2013)
- Australian and New Zealand Guidelines for fresh and marine water quality (ANZECC & ARMCANZ, 2018);
- Best Practice Erosion and Sediment Control guidelines (IECA, 2008); and
- Environmental Protection Regulation (EPR) 2019 and Reef discharge standards for industrial activities guideline (DES, 2021).

### **2.2 PROJECT SPECIFIC STATUTORY DOCUMENTS**

The Project specific statutory documents are:

- Environmental Authority-EA-100265081;
- Mining Lease (ML) 700073; and
- Vulcan South Water Management Plan (once completed).

### **2.3 STRATEGIC APPROACH**

ESC needs to be evaluated and implemented for the following phases of work:

- planning and design (non-operational);
- operation and construction; and
- rehabilitation and mine closure.

This ESC plan does not specifically include techniques for rehabilitation, although many of the given techniques are relevant.

All parties involved in earthworks engaged on site will be given access to the ESC plan and will be required to adhere to all aspects of the plan in the implementation of works undertaken, unless abnormal circumstances prohibit their use.

In addition, consideration should be given to the inclusion of this ESC plan into tender documents and given to prospective tenderer for mine related activities to enable efficient incorporation into daily mine operational procedures.

### **2.4 RESPONSIBILITIES AND ACCOUNTABILITIES**

The management and implementation of the ESC plan is administered through the following key personnel:

- Mine Site General Manager – accountable for the application of this plan and responsible for documentation and revisions of the plan as well as monitoring and auditing of this plan.

- Contractors engaged to undertake work at the Project are responsible for implementation and auditing of this plan.
- Site supervisors - responsible for implementation of this plan.

## 2.5 REEF DISCHARGE STANDARDS FOR INDUSTRIAL ACTIVITIES

New or expanded prescribed ERAs and resource activities are assessed against Section 41AA of the EP Regulation in relation to water quality. Since 1 June 2021, the administering authority must consider section 41AA of the EP Regulation when making an environmental management decision (EMD) for an ERA discharging dissolved inorganic nitrogen (DIN)/fine sediment in the GBR catchment waters.

Section 3.2.3 of DES (2021) states that *“triggers for assessment under section 41AA do not include diffuse sources of contaminated stormwater that contains sediment only. This will allow for an exclusion for stormwater proposed to be managed through erosion and sediment control measures.”*

The Project ESCP has been prepared using the Best Practice Erosion and Sediment Control document (IECA, 2008) and addresses:

- the fullest separation possible of diverted, surface and mine-affected water runoff;
- the diversion of upstream runoff from disturbed areas;
- the stabilisation of soils in disturbed areas; and
- the installation and maintenance of control measures such as sediment and erosion control devices (e.g., silt fences, swales, settling basins, energy dissipaters and vegetated buffers).

Hence surface water and diverted water releases from the Project do not trigger the need for an assessment under Section 41AA of EPR 2019.

---

## 3 EXISTING ENVIRONMENT

### 3.1 REGIONAL DRAINAGE NETWORK

The Project is located within the Isaac River sub-basin of the greater Fitzroy Basin. Figure 1.1 shows the Isaac River catchment to its confluence with Phillips Creek. The catchment area of the Isaac River to Boomerang Creek is 5,226 square kilometres (km<sup>2</sup>).

The Isaac River commences approximately 100 km to the north of the project site within the Denham Range. It drains in a south westerly direction through the Carborough and Kerlong Ranges before turning in a south easterly direction near the Goonyella Riverside Mine. It drains approximately 25 km to the east of the project site, and eventually flows to the Mackenzie River some 130 km to the southeast.

Three open water bodies are located in the upper catchment including Lake Elphinstone, Teviot Creek Dam and Burton Gorge Dam. Lake Elphinstone is a natural lake formed behind the Carborough Range whereas Teviot Creek Dam and Burton Gorge Dam are man-made structures that supply water to Burton and North Goonyella mines in the upper catchment.

Other than along the ranges, the majority of the Isaac River catchment has been cleared for agricultural use or for mining. There are several existing coal mines in the catchment, including Burton, North Goonyella, Goonyella Riverside, Broadmeadow, Broadlea North, Isaac Plains, Moranbah North, Millennium, Daunia, Poitrel, Grosvenor, Peak Downs, Saraji, Norwich Park and Lake Vermont.

Figure 3.5 presents the regional catchments and the local drainage features in the vicinity of the Project. The Project is located in the headwaters of the Boomerang, Hughes, Barret and Harrow creek catchments:

Headwater drainage features of Boomerang Creek, which is a watercourse and tributary of the Isaac River, drains the northern portion of the Project area. Within the Project MLA boundary, Boomerang Creek and its tributaries are identified as drainage lines. Boomerang Creek is identified as a watercourse approximately 1 km downstream (east) of the Project MLA where Drainage lines 1, 2, 3 and 4 join. Boomerang Creek and its tributaries drain from Project MLA boundary via a series of culverts under the Norwich Park Branch Railway.

Hughes Creek is a watercourse and tributary of Boomerang Creek and drains the majority of the southern Project area. Hughes Creek is identified as a watercourse within the Project MLA boundary. Hughes Creek drains from the Project MLA boundary via a rail bridge under the Norwich Park Branch Railway.

Barrett Creek, which is identified as a watercourse within the Project MLA and is a tributary of Hughes Creek, drains a small portion of the southern Project area. Barrett Creek drains from the Project MLA boundary via a culvert under the Norwich Park Branch Railway.

Headwater drainage features of Harrow Creek, which is a tributary of Cherwell Creek and the Isaac River, drains a small portion of the northern Project MLA area. Harrow Creek is identified as a watercourse approximately 2.2 km downstream (northwest) of the Project MLA.

The confluence of Boomerang and Hughes Creek occurs approximately 10 km to the east of the Project. Boomerang Creek drains into the Isaac River a further 10 km to the east of the Project. The catchment area of the Isaac River to Boomerang Creek is approximately 5,226 square kilometres (km<sup>2</sup>). The catchment area of Boomerang Creek is 788 km<sup>2</sup>, of which 177 km<sup>2</sup> makes up the Hughes Creek catchment.

The catchments of Boomerang Creek, Hughes Creek and Barrett Creek commence to the west of the Project area and drain in an easterly direction towards Saraji Road and the Norwich Park Branch



Railway. The Ripstone Creek catchment lies to the north of the Project area and drains into Boomerang Creek approximately 30 km southeast of the Project. The headwater tributaries of Boomerang and Hughes Creek are ephemeral streams which experience flow only after sustained or intense rainfall.

The predominant catchment land uses of Boomerang Creek include undeveloped areas with some stock grazing to the west of Saraji Road and stock grazing and coal mining to the east. Boomerang Creek, Hughes Creek and Barrett Creek flow into the existing BHP Billiton Mitsubishi Alliance (BMA) operations (Peak Downs and Saraji). The existing BMA operations have diverted the original alignment of Boomerang Creek and its tributaries, as well as Harrow Creek to the north. Additional diversions of Boomerang Creek and its floodplain are also planned for approved operations further to the east.

The northwest Project MLA area interacts with a small portion of the Harrow Creek catchment (Figure 3.5). Harrow Creek is a watercourse to the west of the Project that flows, which flows in a northerly direction. Sawmill Creek and Kennedy Creek are named tributaries of Harrow Creek. Harrow Creek flows into Cherwell Creek, which in turn discharges into the Isaac River to the north of the Project.

## 3.2 LOCAL DRAINAGE NETWORK

Figure 3.6 to Figure 3.8 shows the local drainage features within the northern, central and southern Project areas respectively. Drainage features in the north of the Project area (in the vicinity of the highwall trial mining test area) primarily drain to Boomerang Creek. Drainage features in the centre of the Project area (near the Vulcan North pit) primarily drain to Boomerang Creek. Drainage features in the central and southern areas of the Project area (near the Vulcan Main and Vulcan South pits) primarily drain to Hughes Creek and Barrett Creek. All drainage lines within the Project area eventually drain to the Isaac River.

The main drainage features which intersect the mining areas are (Figure 3.6 to Figure 3.8):

- Drainage line 1 (a tributary of Boomerang Creek);
- Drainage line 2 (a tributary of Boomerang Creek);
- Drainage line 6 (a tributary of Boomerang Creek);
- Drainage line 7 (a tributary of Boomerang Creek);
- Hughes Creek; and
- Drainage line 8 (a tributary of Hughes Creek).

### 3.2.1 Drainage line 1 and 2

Drainage lines 1 and 2 are tributaries of Boomerang Creek which drain the northern extent of the Project area (Figure 3.6). Drainage lines 1 and 2 drain a significant portion of the VCM and have previously been described in detail (WRM, 2021).

Drainage line 1 drains the northeastern extent of the Project area, in particular the northern extent of the Highwall trial mining area. Drainage Line 1 crosses the Saraji Road and the Norwich Park branch railway to the northeast of the Project area before discharging into the Peak Downs Mine Lease (ML) downstream of the railway. Drainage Line 1 flows into an existing on-line water storage within the Peak Downs operations before eventually discharging into Drainage Line 2 to the east of the Project boundary. Drainage Line 1 has been diverted and significantly modified within the Peak Downs ML.

A minor drainage feature which is a tributary of Drainage line 2 drains the southern extent of the Highwall trial mining area before discharging into Drainage line 2 at the eastern Project extent (Figure 3.6). Drainage line 2 has a catchment area of approximately 30 km<sup>2</sup>. Drainage Line 2 crosses

the Saraji Road and the Norwich Park branch railway to the east of the Project area before discharging into the Peak Downs ML downstream of the railway.

### 3.2.2 Drainage line 6

Drainage line 6 drains the majority of the Vulcan North mining area. The drainage line passes through a culvert under Saraji Road and the Norwich Park branch railway within the Project area (Figure 3.1). Drainage line 6 discharges into an existing drainage diversion within the Saraji Mine known as East Creek which in turn, passes through the Saraji Mine operation before draining into Boomerang Creek approximately 5 km to the east of the Project.

Drainage line 6 will be diverted as part of the Project to avoid the Vulcan North mining area (Figure 1.3). The 1.8 km long drainage diversion will divert Drainage line 6 into Drainage line 7 during operations. Drainage Line 6 will be reinstated post-mining by constructing a drainage corridor through backfilled spoil. DD2 will collect runoff from the remaining Drainage line 6 catchment. DD2 is a diverted water dam that receives inflows from the rural catchment to the southwest of Vulcan North pit.



Figure 3.1 Photograph of Drainage line 6 passing under Norwich Park Brach railway

### 3.2.3 Drainage line 7

Drainage line 7 (Figure 3.2) lies between the proposed Vulcan North and Vulcan Main mining areas, and north of the TLO and CHPP area. Drainage line 7 will receive releases from sediment dams around the Vulcan North out of pit emplacement area and the diverted water catchment from Drainage line 6 during operations (Section 4.2.2 of WRM, 2023).



Drainage line 7 collects a natural catchment to the west of the Project area and discharges through existing box culverts under Saraji Road and the Norwich Park Branch railway (Figure 3.3). The Drainage line 7 flows into a dam 400 m east of the Project area, which forms part of the drainage diversion known herein as East Creek within the Saraji Mine.



**Figure 3.2 Photograph of Drainage line 7 south of the Vulcan North mining area**



**Figure 3.3 Photograph of Drainage line 7 passing through box culverts under Saraji Road**



### 3.2.4 Hughes Creek

Hughes Creek is a watercourse which collects a significant natural catchment to the west of the Project area. The creek flows west-east between the Vulcan Main and Vulcan South areas, passing under two bridges crossings of Saraji Road and the Norwich Park branch railway (Figure 3.4). A number of drainage features discharge into Hughes Creek to the east of the Project Area, including Barrett Creek and Drainage line 8. Hughes Creek passes through the Saraji Mine operation before discharging to Boomerang Creek, approximately 10 km to the east of the Project area. Hughes Creek has been diverted and significantly modified within the Saraji ML.

A tributary of Hughes Creek flows on the southern edge of the Vulcan Main mining area and will receive releases from sediment dams around the southern side of the Vulcan Main in pit and out of pit emplacement areas and the northern side of the Vulcan South in pit emplacement areas. Hughes Creek will also receive the diverted water catchment from Drainage line 8 during operations (Section 4.2.5 of WRM,2023).

### 3.2.5 Drainage line 8

Drainage line 8 is a tributary of Hughes Creek which flows through the proposed Vulcan South mining area. Drainage line 8 currently passes through box culverts under Saraji Road and the Norwich Park branch Railway before discharging into Hughes Creek to the east of the Project area. Drainage line 8 is proposed to be diverted during operations around the Vulcan South mining area into Hughes Creek (Figure 3.8) to the north. Drainage Line 8 will be reinstated postmining by constructing a drainage corridor through backfilled spoil.

Drainage line 8 is not well defined in its lower reaches (i.e. closer to the proposed Vulcan South mining area) and an existing farm is located on the section of Drainage Line 8 that is to be diverted.



**Figure 3.4 Photograph of Hughes Creek passing under Saraji Road**

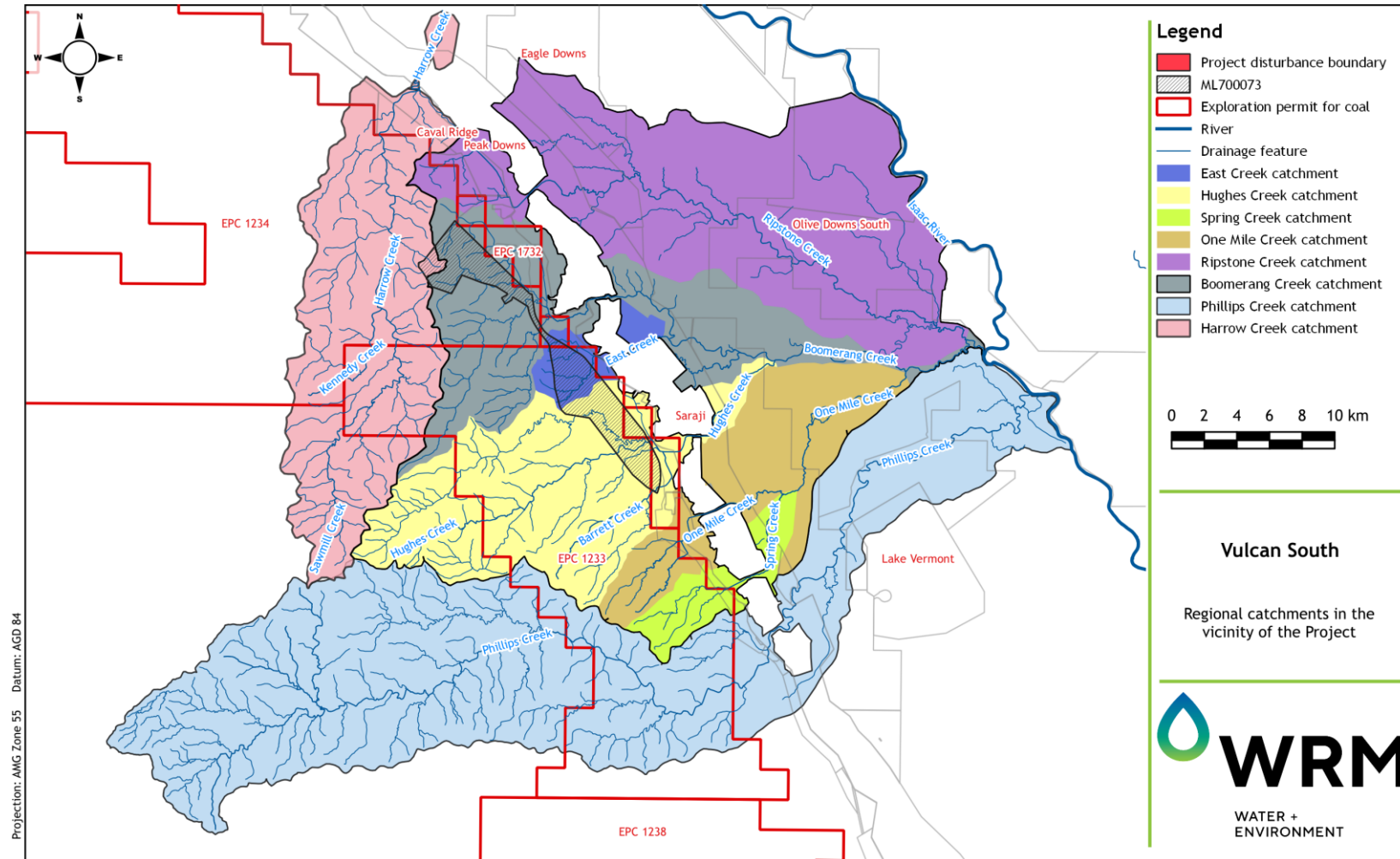

Figure 3.5 Regional catchments in the vicinity of the project



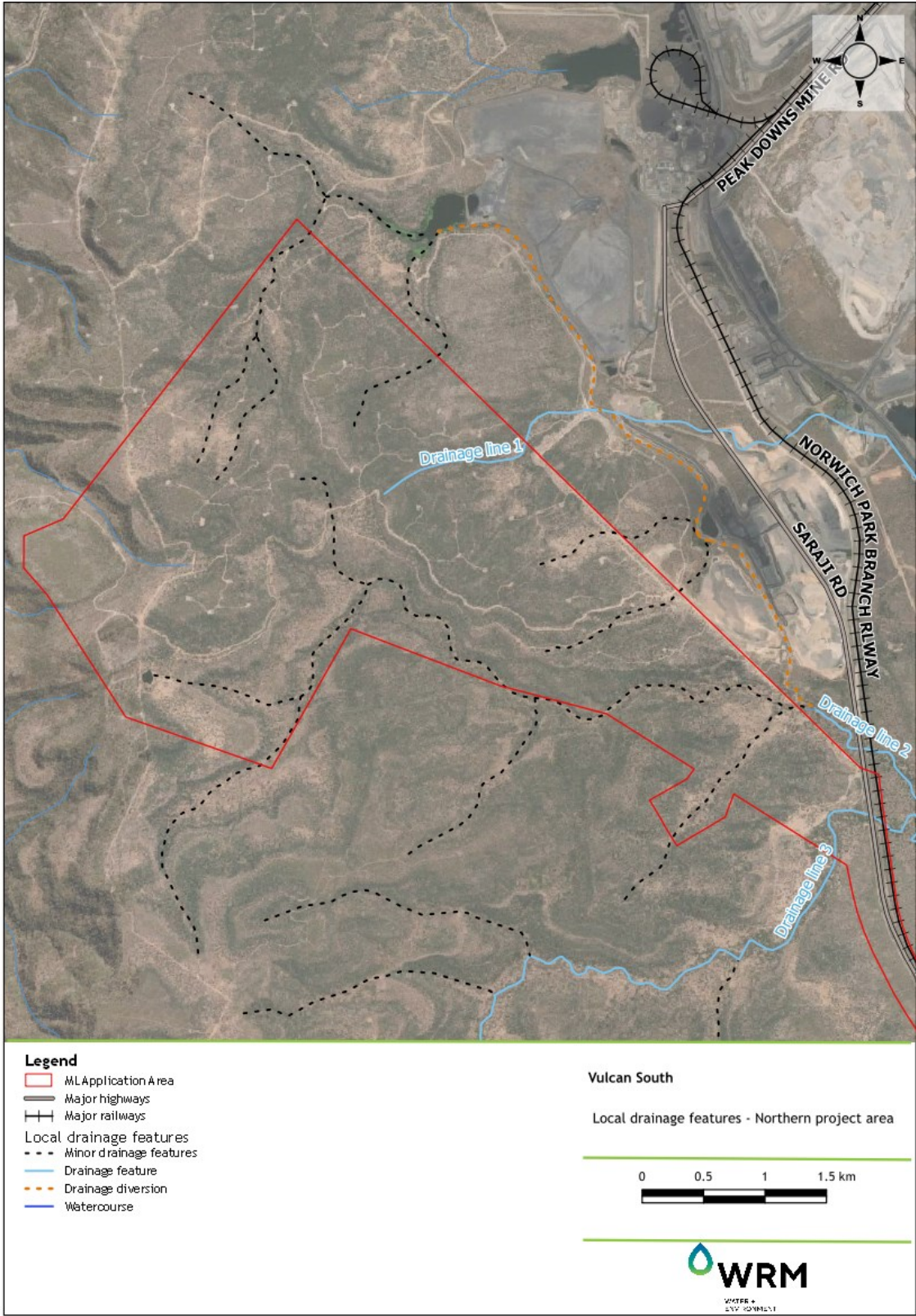

Figure 3.6 Local drainage features – northern project area

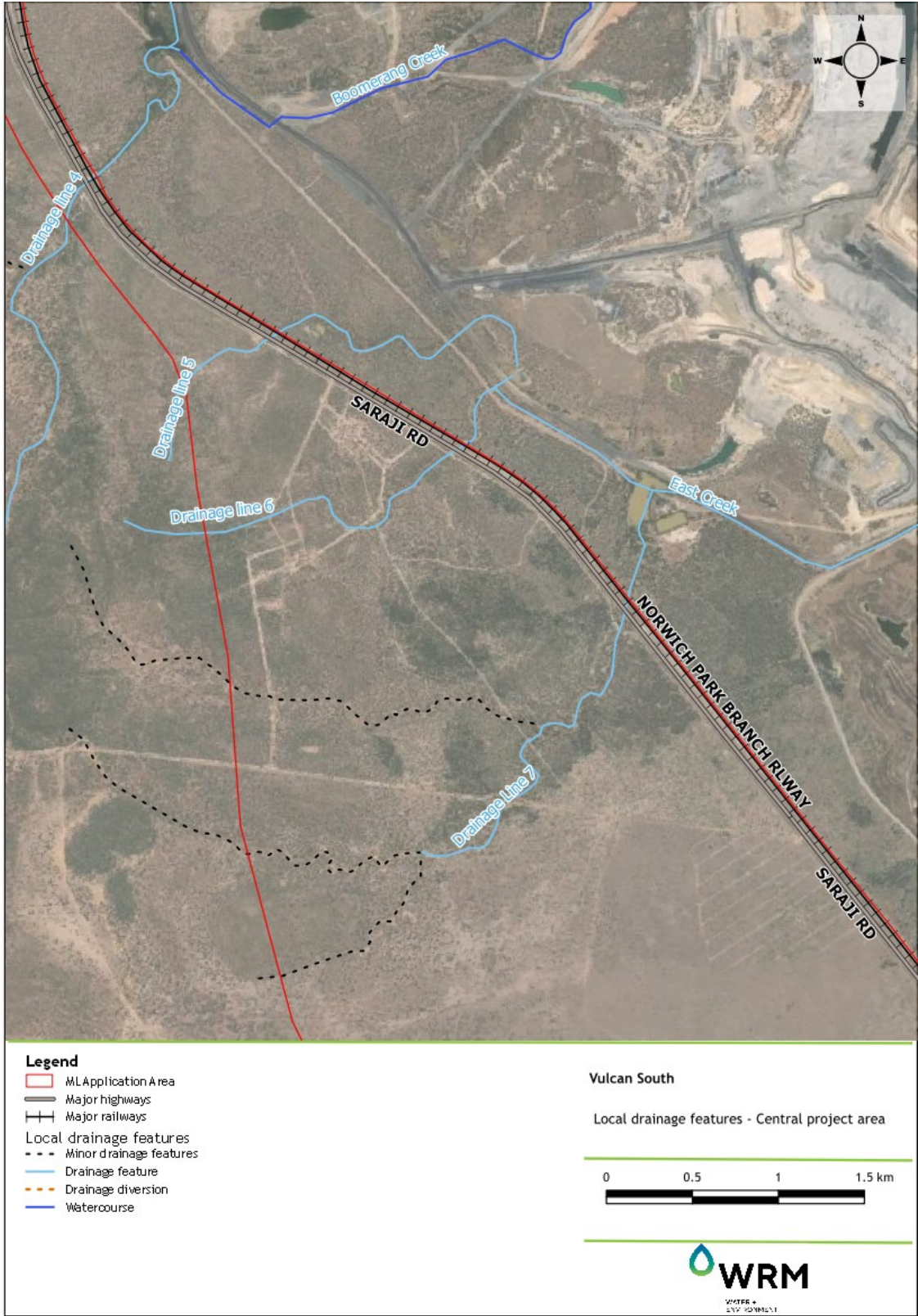

Figure 3.7 Local drainage features – central project area



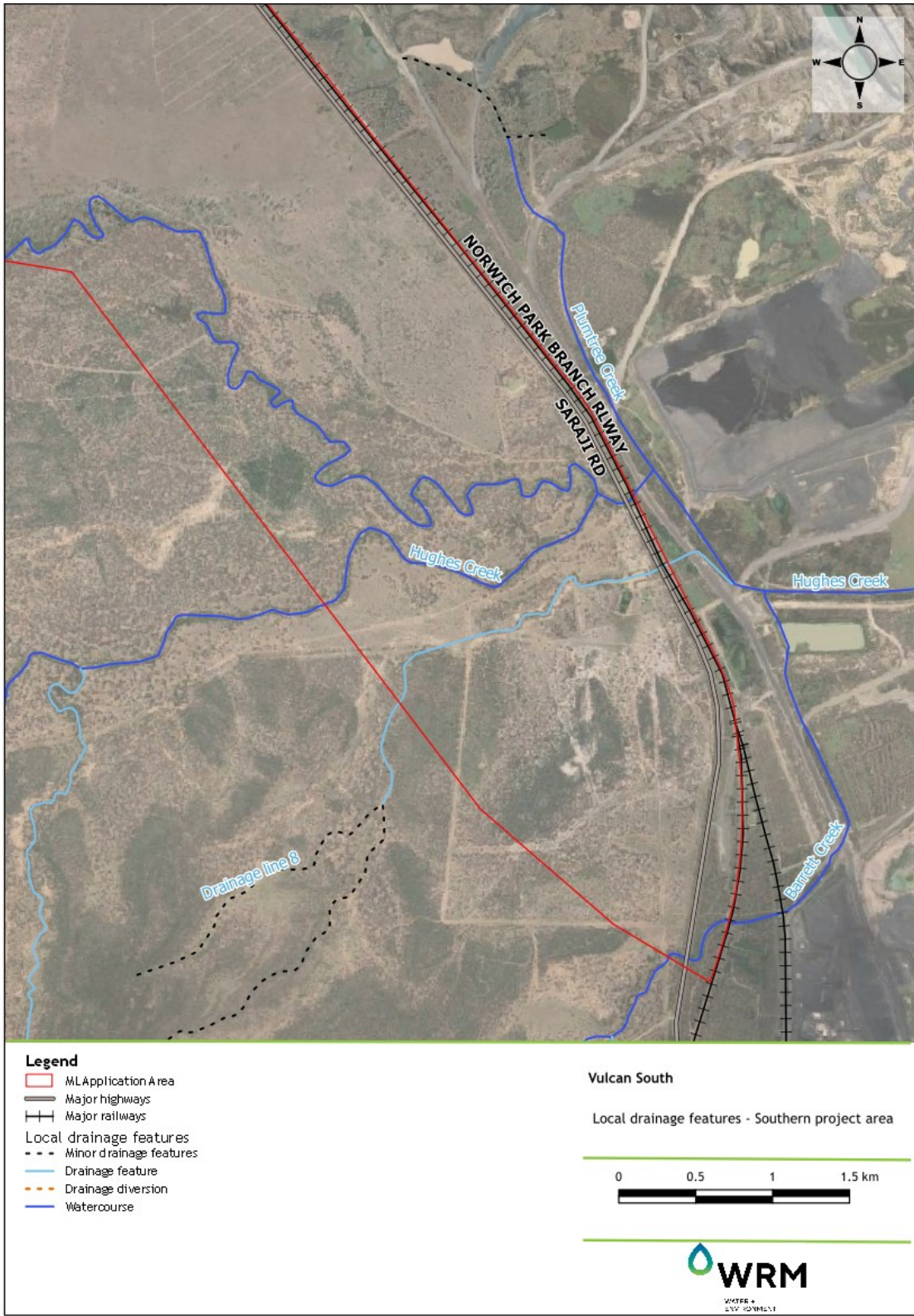

Figure 3.8 Local drainage features – southern project area

### 3.3 TOPOGRAPHY

Figure 3.9 shows the slopes across the Vulcan South ML application area. In general, the slopes are level to very gently inclined, with slopes typically less than or equal to 6% for the Vulcan North, Main and southern project areas. Parts of the Project area near the Highwall trial mining area has slopes of up to 70% along the existing drainage line.

### 3.4 SOIL CHARACTERISTICS

AARC Environmental Solutions Pty Ltd (2022) completed a Soil and Land Suitability Assessment (SLSA) for the Project and surrounds. To characterise the soils at the site, AARC collected 42 detailed soil profiles and analysed 12 laboratory samples from the site vicinity.

The area surrounding the Project is dominated by clastic sedimentary rocks of marine and lacustrine origin, including sandstones, mudstones, siltstones and coal. Surface geology at the site includes Quaternary clay, silt, sand, gravel and soil with colluvial and residual deposits, as well as late Tertiary to Quaternary poorly consolidated sand, silt, clay, minor gravel and high-level alluvial deposits (AARC, 2022).

#### 3.4.1 Soil management units

AARC mapped the Soil Management Units (SMUs) across the site using the methodologies specified in the Guidelines for Surveying Soil and Land Resources (McKenzie et al, 2008) based on soil morphology, parent material and land attributes.

A description of each SMU found within the Project area is outlined in Table 3.1. The majority of the site consists of the Limpopo SMU, the Orange SMU and the Zambezi SMU.

**Table 3.1 Soil Management Units surveyed on site**

Soil Management Unit	Description
Crocodile	A shallow rocky soil unit associated with hill slopes and plateaus. Soil textures grade from loam at the surface, to loamy sands with depth; often containing rock material with little to no pedologic development throughout the solum.
Limpopo	The Limpopo unit is a brown texture-contrast soil. Soil textures predominantly grade from sands to clay sands in the surface soils to light clays in deeper horizons.
Zambezi	A predominantly grey coloured texture contrast soil with surface soils consisting of sands, increasing in clay content in deeper horizons. Lower horizons display diffuse orange to yellow mottles.
Orange	A dark cracking clay associated with the flat grassy plains in the middle of the Project area. The predominant textures of soils within this unit range from light clays in surface soils to light medium clays in deeper horizons.
Sabie	A dark-coloured texture contrast soil with surface soils consisting of sands, increasing in clay content in deeper horizons. Lower horizons display red to orange mottles.
Komati	A dark brown coloured soil unit displaying vertic properties. Soil textures predominantly grade from light to medium clays with calcareous segregations occurring within the deeper horizons.
Fish	A predominantly sandy soil unit occurring on the flats of the southeastern end of the Project area. Soil textures grade from loamy sand at the surface, to clay and silty sands with depth.
Kei	A brown coloured soil unit occurring on the flats of the southeastern end of the Project area. Soil textures grade from

Soil Management Unit	Description
	clayey to loamy sands at the surface, to medium clay with depth and orange to yellow mottles present in the deeper horizons.

### 3.4.2 Sodic and dispersive soils

Sodic soils contain large concentrations of Sodium relative to other cations. These soils have a degree of dispersivity and can accelerate erosion.

AARC (2022) identified areas of high sodicity on site through the measurement of the Exchangeable sodium percentage and Emerson Class of surveyed soils. The Crocodile and Kei SMU were identified as having a low risk of dispersion and were not identified as being sodic.

For the remaining SMUs, AARC (2019) identified the depth horizons with sodic properties as follows:

- Fish SMU: Sodic below a depth of 0.2 m;
- Komati SMU: Sodic below a depth of 0.2 m;
- Limpopo SMU: Sodic below a depth of 0.5 m;
- Orange SMU: Sodic below a depth of 0.2 m;
- Sabie SMU: Sodic below a depth of 0.2 m; and
- Zambezi SMU: Sodic below a depth of 0.5 m.

To control erosion from sodic dispersive soils, soils will be selectively handled and managed where required. Further details are provided in the Vulcan South Progressive Rehabilitation and Closure Plan (METServe, 2022).

## 3.5 ENVIRONMENTAL VALUES

The Queensland Water Quality Guidelines and Environmental Protection (Water and Wetland Biodiversity) Policy (EPP Water) guidelines establish environmental values (EVs) and water quality objectives (WQOs) for natural waters in Queensland. The Project is located within the 'Isaac western upland tributaries' area of the Isaac River sub-basin. Under the EPP Water, the following EVs have been nominated for this area:

- Aquatic ecosystems;
- Irrigation;
- Farm supply/use;
- Stock water;
- Aquaculture;
- Human consumption;
- Primary recreation;
- Secondary recreation;
- Visual recreation;
- Drinking water;
- Industrial use; and
- Cultural and spiritual values.



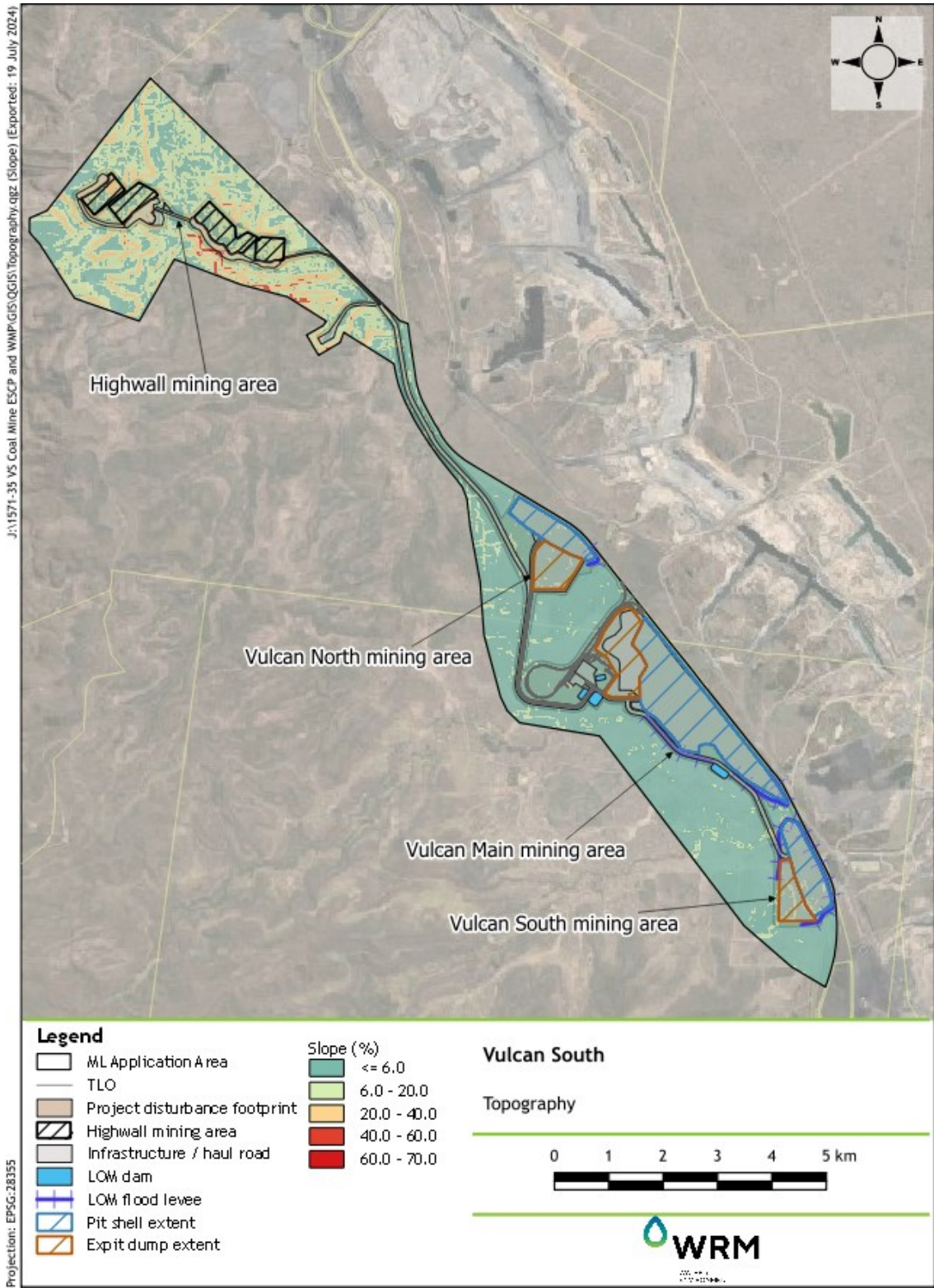

Figure 3.9 Percentage slope across the project area



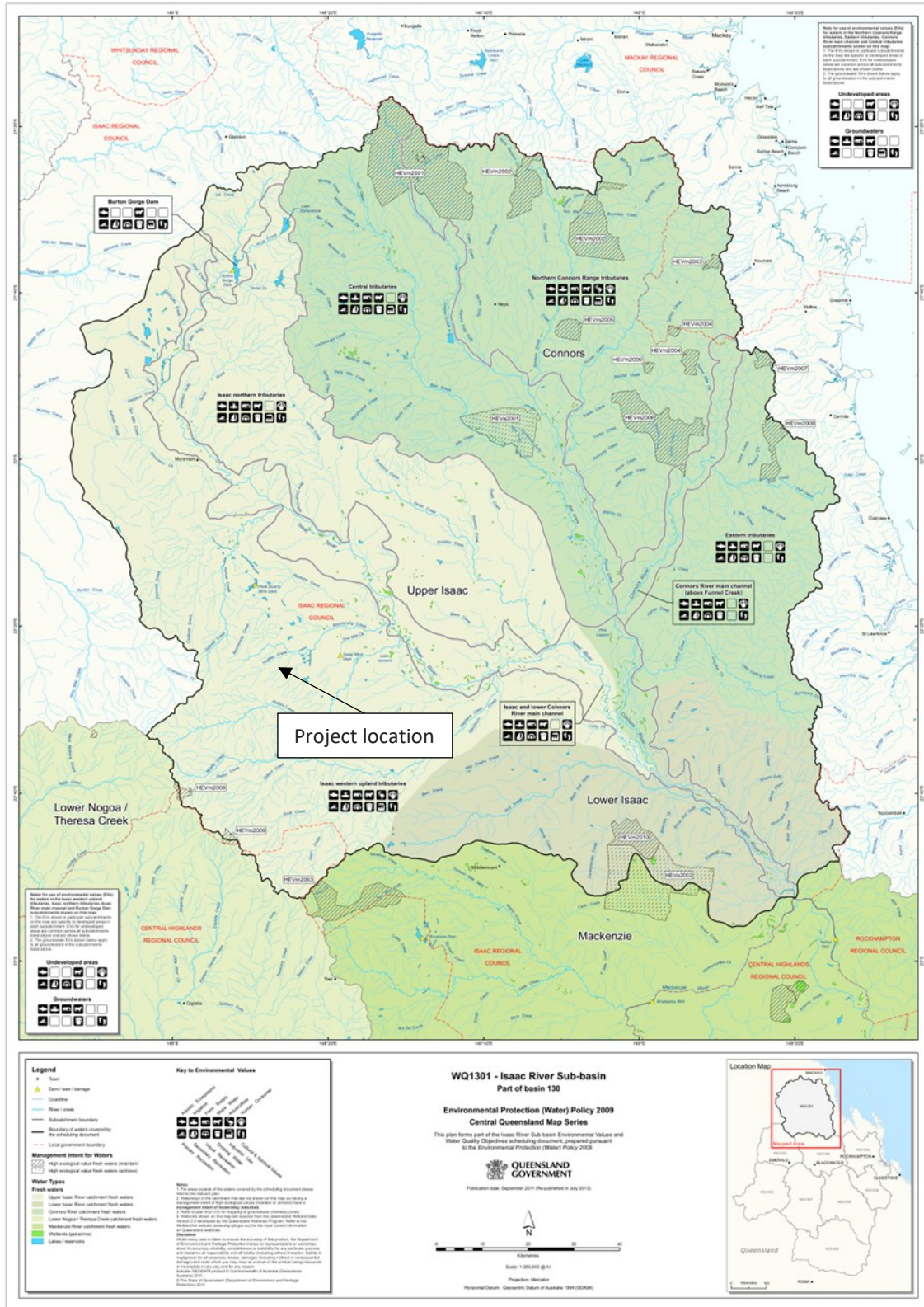

Figure 3.10 Isaac River Sub-Basin EVs (source: DES, 2013)

---

## **4 EROSION AND SEDIMENT CONTROL**

### **4.1 OVERVIEW**

This ESC plan is intended to assist in the management, reduction and mitigation of erosion and consequent sediment transport within and from the Project.

Preventing unacceptable levels of sediment and contaminants from leaving the lease and entering the receiving waters is one of the most important functions of ESC, which is managed by compliance with the Environmental Authority. As per IECA (2008) this ESC plan adopts the three cornerstones of ESC as follows:

- Drainage control – prevention or reduction of soil erosion caused by concentrated flows and appropriate management and separation of the movement of clean and dirty water through the area of concern.
- Erosion control – prevention or minimisation of soil erosion (from dispersive, non-dispersive or competent material) caused by rain drop impact and exacerbated overland flow on disturbed surfaces.
- Sediment control – trapping or retention of sediment either moving along the land surface, contained within runoff (i.e. from up-slope erosion) or from windborne particles.

Erosion control and sediment control are two very different activities. Erosion control measures concentrate on preventing, or at least minimising, soil erosion. Sediment control measures concentrate on trapping sediment displaced by up-slope soil erosion. In general, the most efficient and cost-effective way of minimising sedimentation is to minimise the extent, duration and severity of soil erosion. In addition, best practice sediment control measures cannot, on their own, be relied upon to provide adequate environmental protection.

### **4.2 PRINCIPLES OF ESC**

For ESC to be effective, the following fundamentals are required (IECA, 2008):

- ensure ESC measures are designed and constructed effectively;
- minimise the duration and extent of soil exposure;
- promptly stabilise disturbed areas;
- maximise sediment retention on the site;
- control water movement through the site;
- minimise soil erosion wherever possible rather than applying down slope sediment controls;
- utilise existing topography and adopt construction practices that minimise soil erosion and sediment discharge from area;
- integrate erosion and sediment control issues / measures into the planning phases of mine operations;
- choose the ESC technique to account for site conditions such as soil, weather and construction conditions;
- maintain all ESC measures in proper working order at all times; and
- monitor the site and adjust ESC practices to maintain the required performance standard.

### 4.3 POTENTIAL SOURCES OF EROSION

Operations at VS may result in the alteration of existing surface water flow patterns by mining activities and through diversion drains. Erosion may occur due to the following mining activities:

- Waste rock stockpile;
- Open cut mining;
- Cleared land ahead of mining or other mining related activities;
- Installation of services and infrastructure;
- Changes to drainage lines and/or catchment;
- Ore stockpiles and ore handling equipment including mobile equipment, ore crushing equipment and conveyors;
- runoff from construction and maintenance on haul roads;
- runoff from the construction of and maintenance of internal access roads;
- vehicle and equipment movements; and
- disturbed areas not yet rehabilitated.

Potential erosion and sediment sources as well as the potential contaminants and impact at the Project are presented in Table 4.1.

Although this ESC plan primarily focuses on erosion and sediment control where water is the causal factor, it should be recognised that, particularly in drier environments, wind also plays a significant role in erosion and the potential for sediment deposition to surrounding receiving environments.

**Table 4.1 Potential erosion and sediment sources**

Disturbance category	Potential contaminant	Potential impacts
<i>Spoil</i>		
Active/inactive	Unconsolidated material with varying quantities of saline and sediment pre-disposition Bare areas vulnerable to storm activity Acid mine drainage (AMD)	Sheet and rill erosion of potentially alkaline/acidic/saline deposits leading to deposition of contaminants and sediment volumes. Sediments causing damage to receiving waters through reduction in water quality and degradation of in-stream habitats
Topsoiled (to be revegetated)	Unconsolidated materials, sediment and turbidity	Sheet and rill erosion leading to sedimentation of waterways and loss of valuable rehabilitation material
Topsoiled, ripped and seeded	Unconsolidated materials, sediment and turbidity	Minimal once established
<i>Peripheral lands</i>		

Disturbance category	Potential contaminant	Potential impacts
Exploratory and access tracks	Disturbance of natural landform resulting in possible bare landforms increasing sediments in natural runoff	Exacerbation of rill and gully erosion leading to movement and deposition of sediments potentially causing damage to water quality and in stream habitat of receiving waters
Haul roads	Disturbed materials from surface of the road, erosion of table drain material vulnerable to storm activity	Sedimentation of nearby watercourses
Industrial Areas	Hydrocarbons and hydrocarbon contaminated sediments	Water quality impacts
Sediment runoff from hardstand areas	Leaching and erosion of soils containing hydrocarbons and movement and release of hydrocarbons into surrounding environment	Sedimentation of nearby watercourses
Exploration activity	Disturbed materials, sediment and turbidity	Sedimentation of nearby watercourses
Land clearing (woody vegetation)	Disturbed materials, sediment and turbidity	Sedimentation of nearby watercourses
Drainage channels	Disturbance of landform resulting in possible bare landforms increasing sediments in runoff	Sheet, tunnel, rill and gully erosion leading to movement and deposition of sediments, deleteriously impacting on receiving waters
Licensed stream diversions / levees	Disturbance of landform resulting in possible bare landforms increasing sediments in runoff	Sheet, tunnel, rill and gully erosion leading to movement and deposition of sediments, deleteriously impacting on receiving waters

#### 4.4 EROSION POTENTIAL

Undertaking an assessment for risk of erosion is essential to determine the appropriate ESC technique to apply. There are five main categories that need to be taken into consideration, all of which influence the erosion potential and the type of control measure(s) applicable:

- soil classification;
- average slope of disturbance area;
- area and duration of soil disturbance;
- location within the catchment (and whether run-off from upslope can be controlled); and
- proximity to waterways.

An example of a simple erosion assessment is presented in Appendix A (IECA 2008, Appendix F) that identifies low-risk and high-risk sites. This type of assessment may help to determine the high-risk areas of erosion potential.

#### 4.4.1 Soils

Soils are classified into three categories:

- dispersive soil;
- non dispersive soil; and
- blocky / competent material.

The following is provided as background to identifying soil / material types.

Dispersive soils are structurally unstable in water and tend to break down into their constituent particles which consequently cloud the water. Dispersive soils are highly susceptible to erosion on slopes and drains when exposed. Dispersive soils will be treated or completely buried under a layer of non-dispersive soil before attempting any erosion control measures.

Non-dispersive soils are characterised by large, water-stable aggregates separated by large pore spaces that absorb water rapidly. These soils are typically high in clay content although some clays are highly dispersive and break down when wet making them highly erodible (i.e. dispersive). Sandy soils are generally non-dispersive on gently sloping land, however are dispersive on steep slopes.

Blocky / competent soil material is structurally sound and typically does not contribute a large portion of erosion problems or sediment runoff. These materials may be used to construct various erosion and sediment control techniques.

Reference should be given to AARC (2019) and the SMU's mapped across the Project site when identifying soils for erosion and sediment control. In particular, specific consideration should be given to the location of sodic dispersive soils mapped by AARC (2019) and described in Section 3.4.

If there is uncertainty surrounding the soil type for any area of activity where this ESC plan needs to be referenced, appropriate steps will be undertaken to determine soil type. This may include undertaking suitable soil assessment as per published documentation (e.g. IECA 2008).

#### 4.4.2 Slope

The steepness of the slope and slope length are important determinants in the erosion risk of a site. The Australian Soils and Landscapes Handbook identifies that slopes can be categorised by their percentage or degree of slope. These slope categories of relevance to the Project are defined in Table 4.2.

**Table 4.2 Definition of slope class**

Slope Class	Approximate Slope Values			
	Tangent (% Slope)		Degrees	
	Boundary	Average	Boundary	Average
Level	1	0.6	0°35'	0°20'
Very Gently Inclined	3	1	1°35'	1°
Gently Inclined	10	6	5°35'	3°
Moderately Inclined	32	20	18°	10°

#### 4.4.3 Area and duration

A principal of ESC is to minimise the extent and duration of soil disturbance. Therefore, mining schedules will aim to minimise the duration for which open soils are exposed to the erosive elements (wind, rain and flowing water). Reducing the period where soils are exposed to erosive elements



during the construction phase lessens opportunity for displaced sediment to enter into the surrounding environment.

Strategies to minimise increased risk of erosion during the operational phase of the mine site include:

- minimise the extent of the disturbance;
- prompt revegetation of non-operational disturbed area;
- ensure both temporary earthworks and permanent land-shaping provide a landform that minimises erosion; and
- design temporary runoff collection, conveyance and disposal systems to minimise erosion prior to commencement.

#### **4.4.4 Location within the localised catchments**

One of the major principles in achieving effective erosion and sediment control across any site is the necessity to separate run-off from undisturbed catchments and disturbed catchments. Disturbed sites positioned low in a localised catchment with the potential to receive overland or flood flows represent an increased erosion risk. It is therefore necessary to establish site drainage works to convey overland flows safely through or around a site during the disturbance period. Particular attention will need to be paid to the discharge areas of these diversions.

#### **4.4.5 Waterways**

The proximity to watercourses may trigger an increased level of planning. Disturbances to existing waterways will be avoided wherever practical.

During operational phases the proximity of ESC measures to watercourses will be undertaken where practicable and reasonable. Design will take into account floodplain extent, soil conditions and flood immunity of the selected ESC measure.

Within this process any mitigation works required to minimise erosion and sediment transport will be detailed. Any discharges to a watercourse are conditional to the environmental authority for the Project.

## 5 EROSION CONTROL MEASURES

### 5.1 OVERVIEW

Soil erosion is the process through which the effects of wind, water or physical action displace soil particles, causing them to be transported. This section discusses the potential measures to mitigate or reduce erosion caused by water. The most common forms of water erosion at the Project are:

- Splash erosion is the spattering of soil particles caused by the impact of raindrops on soil;
- Sheet erosion is the uniform removal of soil in thin layers from sloping land;
- Rill erosion is the removal of soil by water concentrated in small but well-defined channels; and
- Gully erosion produces channels deeper and larger than rills (generally greater than 300 mm deep).

### 5.2 EROSION CONTROL TECHNIQUES

#### 5.2.1 Control of erosion on slopes

A list of appropriate erosion control measures to be used on flat, mild and steep slopes is given in Table 5.1.

**Table 5.1 Erosion control measures on slopes**

Flat Land (flatter than 1 in 10)	Mild Slopes (1 in 10 – 1 in 4)	Steep Slopes (steeper than 1 in 4)
Gravelling	Mulching	Cellular Confinement Systems
Mulching	Revegetation	Revegetation
Revegetation	Rock Mulching	Rock Armouring

#### 5.2.2 Soil stabilisation and protection

Generally, erosion control involves engaging rehabilitation methods. A list of additional erosion control techniques is also given in Table 5.2.

**Table 5.2 Summary of erosion control techniques**

Technique	Typical Use
Cellular confinement systems	Containment of topsoil or rock mulch on medium to steep slopes Control erosion on non-vegetated medium to steep slopes such as bridge abutments
Compost blanket	Used during the revegetation of steep slopes either incorporating grasses or other plants Particularly useful when the slope is too steep for the placement of topsoil, or when sufficient topsoil is absent from the slope
Gravelling	Protection of non-vegetated soils from raindrop impact erosion Stabilisation of site office area, car parks and access roads
Heavy mulching	Stabilisation of soil surfaces that are expected to remain non-vegetated for medium to long periods Suppression of weed growth on non-grassed areas
Light mulching	Control of raindrop impact erosion on flat and mild slopes. May be placed on steeper slopes with appropriate anchoring Control water loss and assist seed germination on newly seeded soil
Revegetation	Temporary and permanent stabilisation of soil Stabilisation of long term stockpiles
Rock mulching	Stabilisation of long term, non-vegetated banks and minor drainage channels
Soil binders	Dust control Stabilisation of unsealed roads
Gypsum	Amelioration of sodic soils (identified in Section 3.4) through the addition of gypsum during earthworks
Topsoil stockpile management	Erosion management measures as outlined in Section 5 Segregation of saline or sodic soils and clear demarcation and labelling/recording of stockpiles to ensure appropriate use of the resource



---

## 6 DRAINAGE CONTROL MEASURES

### 6.1 OVERVIEW

This section outlines the measures to be taken when constructing drainage channels at the Project to minimise erosion and downstream sedimentation. Control measures for four different drainage channels are discussed as follows:

- permanent watercourse drainage (diversions) requiring a licence to disturb under the Water Act 2000 or approval to divert under the Environmental Protection Act 1994. Erosion control measures for these diversions are not specifically addressed in this Plan.
- permanent drainage that does not require regulatory approval but will remain in place at the end of mine life and effectively act as a watercourse.
- operational drainage in low gradient areas such as catch drains, diversion channels or flow diversion banks that either collect concentrated flow or overland flow.
- operational drainage down slopes such as chute drains.

### 6.2 PERMANENT DRAINAGE

Permanent drainage refers to diversion channels that will be in place at the end of mine life. These channels require a higher level of design to limit the potential maintenance liability once mining has ceased. Given this, it is recommended that permanent drainage channels be designed by a suitably qualified person in accordance with the DNRM guidelines entitled *Guideline: Works that interfere with water in a watercourse—watercourse diversions* (DNRM, 2014).

Any permanent diversion will be designed such that it appears and functions as a natural feature in the landscape largely indistinguishable from the natural watercourses in the area (DNRM, 2014). A natural channel or flow path has features that develop through geomorphologic processes, such as channel and floodplain capacity, meanders, riffles and vegetation, to provide an environment where these conditions can continue to develop at a rate consistent with its environment. This is referred to as dynamic equilibrium. Similar features will be designed into the diversion channel in order to obtain a similar dynamic equilibrium.

Where the diversion is replacing an existing channel such as a gully, the existing gully will be used as a ‘template’ to design the diversion. That is, the diversion design will mimic the channel shape, floodplain capacity, bed slope etc. of the natural channel it replaces, where possible. Where the diversion collects an increased catchment of overland flow as it traverses downstream, a nearby natural channel that has a similar catchment area could be used as a template. Alternatively, the upper limits of stream powers, velocities and shear stresses for natural Bowen Basin watercourses, given in the DNRM (2014) guideline will be used.

For all permanent diversions, vegetation will be used as the primary method of stabilising channel banks, terraces and floodplain drainage paths as engineering methods may not limit the liability for long term maintenance cost post mining.

### 6.3 OPERATIONAL DRAINAGE CONTROLS

#### 6.3.1 Design standards

Table 6.1 shows the recommended design standard of operational drainage structures at the Project. Operational drainage controls that have an anticipated design life of 12 months to 24 months will be designed to cater for a 5-year Average Recurrence Interval (ARI) design storm to provide effective separation of clean and dirty runoff (IECA, 2008). This may involve a combination of channels and

floodplain levees. Temporary culvert crossings will have a hydraulic capacity of the 1-year ARI design storm.

**Table 6.1 Drainage design standards for temporary drainage works**

Anticipated Design Life (months)	Design Standard (Years ARI)
< 12	2
12 to 24	5
> 24	100

### 6.3.2 Drainage design techniques

In accordance with IECA (2008), drainage channels, whether permanent or temporary, will be designed and constructed at a gradient that limits the maximum flow velocity for the adopted design event standard (refer Table 6.1) to a value not exceeding the maximum allowable flow velocity for the given surface material. Excessive flow velocities can cause channel erosion, usually along the invert of the drain, which can then lead to bank slumping and widening of the channel. Table 6.2 lists allowable flow velocities for earth lines drains as per IECA (2008).

The flow velocity can be reduced by either:

- Reducing the depth of flow (increasing the width of the channel);
- Reducing the bed slope;
- Reducing the peak discharge (reducing catchment area); or
- Increasing channel roughness.

If the channel width, depth or gradient cannot be altered, then there are two options for controlling erosion as follows:

- Reduce the flow velocity through the placement of rock check dams;
- Increase the effective scour resistance in the channel through the placement of an effective channel liner such as rock or an appropriate liner.

**Table 6.2 Allowable flow velocities for open earth lined drains**

Soil description	Allowable velocity (m/s)	Comments
Extremely erodible soils	0.3	<ul style="list-style-type: none"> <li>• Dispersive clays are highly erodible at low velocities and therefore must be treated (e.g. with gypsum) or covered with a minimum of 100mm of stable soil.</li> </ul>
Sandy soils	0.45	
Highly erodible soils	0.4 to 0.5	<ul style="list-style-type: none"> <li>• Highly erodible soils may include: Lithosols, Alluvials, Podzols, Siliceous sands, Solochs, Solodized solonetz, Grey podzolics, some Black earths, fine surface texture-contract soils and Soil Groups ML and CL.</li> </ul>
Sandy loam soils	0.5	
Moderately erodible soils	0.6	
Silty loam soils	0.6	<ul style="list-style-type: none"> <li>• Moderately erodible may include: Red earths, Red or Yellow podzolics, some Black earths, Grey or Brown clays, Prairie soils and Soil Groups SW, SP, SM, SC.</li> </ul>
Low erodible soils	0.7	
Firm loam soils	0.7	
Stiff clay very colloidal soils	1.1	

- Erosion-resistant soils may include: Xanthozem, Euchrozem, Krasnozems, some Red earth soils and Soil Groups GW, GP, GM, GC, MH and CH.

### 6.3.3 Drain velocity control structures

A list of appropriate check dam velocity control structures is given in Table 6.3.

**Table 6.3 Velocity control structures for channels and drains**

Technique	Typical use
Fibre roll	<ul style="list-style-type: none"> <li>• Biodegradable logs</li> <li>• Used in wide shallow drains where logs can be successfully anchored down</li> <li>• Used in locations where it is desirable to integrate into the vegetation, such as vegetated channels</li> <li>• Minor sediment trap</li> </ul>
Rock check dams (see Figure 6.1)	<ul style="list-style-type: none"> <li>• Used in drains with a depth exceeding 0.5 m and a gradient less than 10%</li> <li>• Minor sediment trap</li> </ul>
Recessed rock check dams	<ul style="list-style-type: none"> <li>• Used in wide, high velocity, shallow channels where sandbag check dams would likely wash away.</li> <li>• Recessed into the soil to maintain hydraulic capacity in the channel</li> <li>• Minor sediment trap</li> </ul>
Sandbag check dams	<ul style="list-style-type: none"> <li>• Used in shallow drains with a depth less than 50 mm and gradient less than 10%</li> <li>• These check dams are small and less likely to divert water out of the drain</li> <li>• Minor sediment trap</li> </ul>
Triangular ditch check	<ul style="list-style-type: none"> <li>• Commercially available, reusable product</li> <li>• Commonly used to stabilise newly formed table drains</li> <li>• Used in drains with less than 10% gradient</li> <li>• Minor sediment trap</li> </ul>



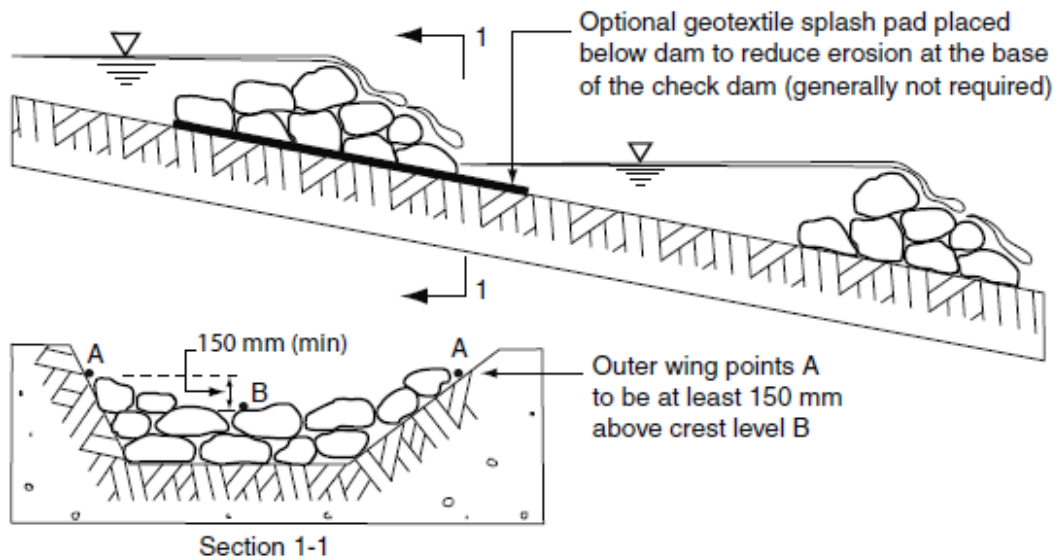

Figure 6.1 Typical rock check dam configuration (IECA, 2008)

### 6.3.4 Channel linings

A list of appropriate channel linings to provide effective scour protection is given in Table 6.4.

Table 6.4 Scour protection and lining types for channels

Technique	Typical use
Cellular confinement system	<ul style="list-style-type: none"> <li>Typically used to stabilise chutes when the only local supply of rock consists of rock smaller than 200 mm</li> <li>May be filled with small rocks and grassed to form a permanent reinforced grassed chute</li> <li>Also used to form a temporary construction access across dry sandy bed streams</li> </ul>
Grass lining	<ul style="list-style-type: none"> <li>Permanent protection of low to medium velocity chutes and channels</li> <li>Requires suitable growing medium and time to establish</li> </ul>
Hard armouring	<ul style="list-style-type: none"> <li>Hard armouring systems include corrugated sheet metal, reinforced concrete and shotcrete</li> </ul>
Rock mattresses	<ul style="list-style-type: none"> <li>Suitable high velocity chutes and spillways</li> </ul>
Rock lining (see Figure 6.2)	<ul style="list-style-type: none"> <li>High velocity drainage channels</li> <li>Drainage chutes</li> <li>Sediment basin spillways</li> </ul>

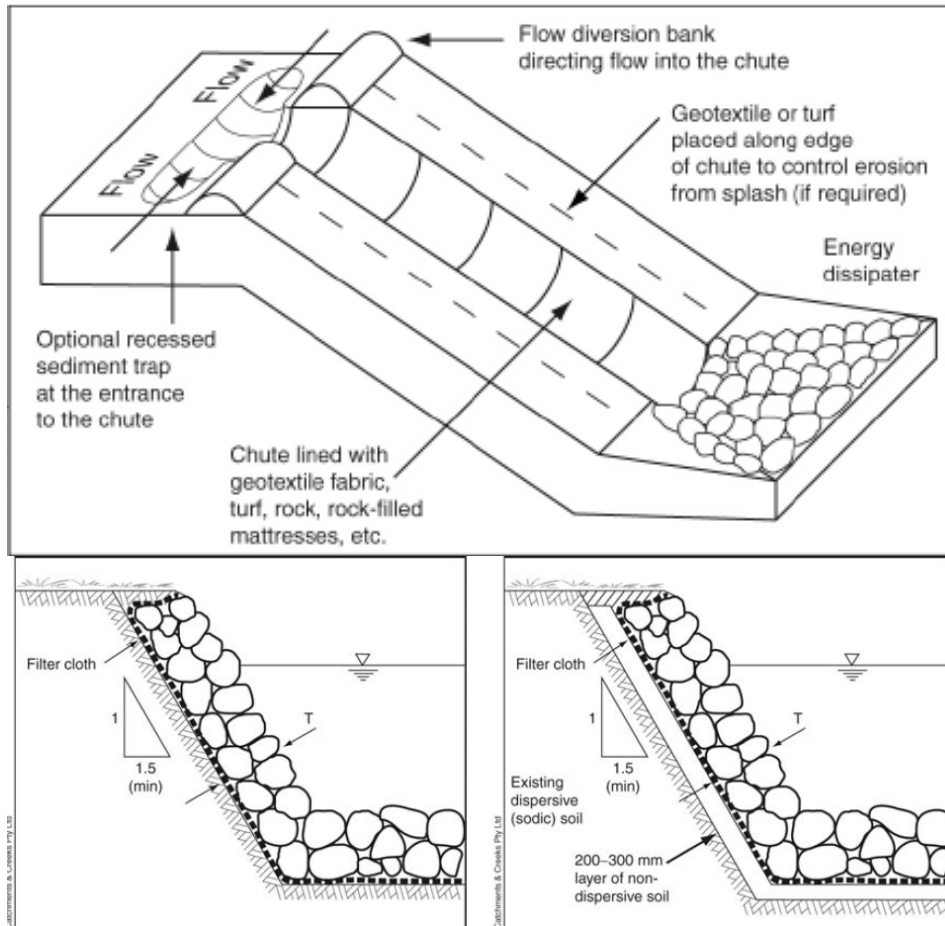

**Figure 6.2 Typical rock placement in a chute (IECA, 2008)**

### 6.3.5 Outlet structures

A list of appropriate outlet structures to provide effective scour protection is given in Table 6.5.

**Table 6.5 Scour protection for channel and drain outlets**

Technique	Typical use
Level spreader (see Figure 6.3)	<ul style="list-style-type: none"> <li>• Conversion of minor concentrated flows back to sheet flow</li> </ul>
Rock protection (see Figure 6.4)	<ul style="list-style-type: none"> <li>• Used at the end of chute drains to dissipate energy and control scour</li> <li>• Used as a permanent energy dissipater on pipe and culvert outlets</li> </ul>

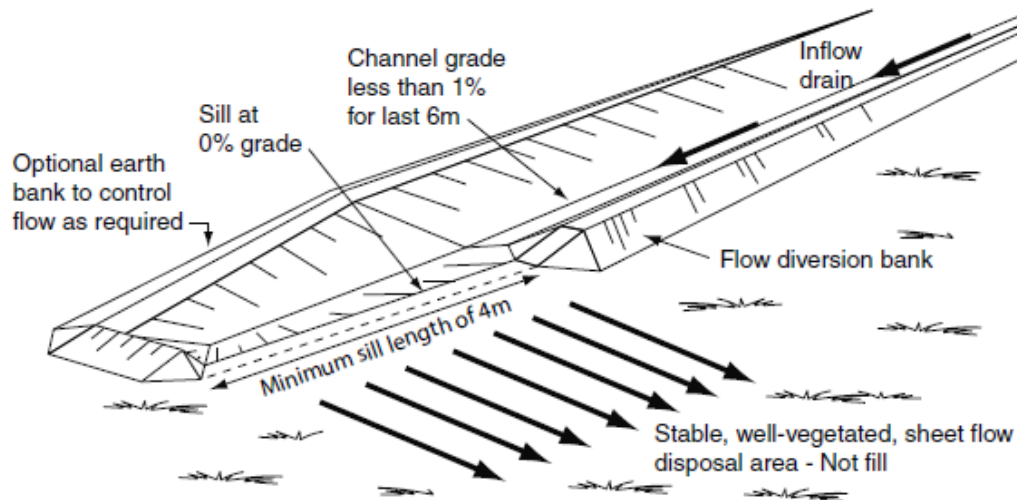

Figure 6.3 Typical level spreader configuration (IECA, 2008)

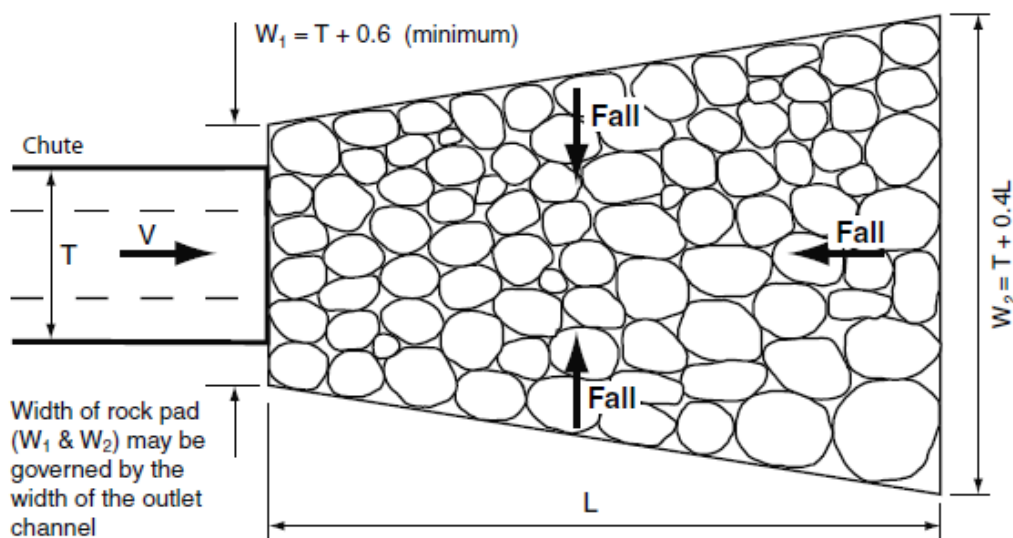

Figure 6.4 Typical energy dissipater configuration (IECA, 2008)

### 6.3.6 Drainage control on unsealed roads

The following general principals will be followed in the design of drainage controls for unsealed roads:

- Stormwater runoff from unsealed roads will be designed to allow shedding at regular intervals. The runoff will be discharged into a sediment trap or released as sheet flow via a level spreader into adjacent grassland.
- Where stormwater runoff from unsealed roads collects within table drains adjacent to the roadway, this water will ideally be discharged from the table drain at regular intervals.



Where table drains are steep and water cannot shed, such as through a cutting or into a river channel, the controls given in Table 6.3 and Table 6.4 will be considered.

- When access is required across a slope, the road will be sited as close as possible to the contour of the land. This allows upslope water runoff to pass evenly across the track, thus avoiding concentrated flow.
- When an access road diagonally traverses a slope, the road will likely collect and concentrate upslope stormwater runoff. The collected runoff will need to shed at regular intervals using a level spreader or drainage channels constructed.
- Wherever practical, table drains will form wide U-shaped drains to minimise potential invert erosion. Deep V-shaped drains will be avoided where roads are constructed on steep slopes along a cutting.

### 6.3.7 Watercourse crossings

Watercourse crossings may consist of fords, culverts, or bridges. The following general principles will be followed in the design of drainage controls for watercourse crossings:

- Where fish passage is to be considered, a bridge structure is preferred otherwise a ford or buried box culvert with earth rock bed.
- Culvert designs will consider the effects of debris blockages and potential erosive forces caused by overtopping flows. Culverts will have a flow capacity at least equal to the normal channel capacity of the watercourse when the water level is just below the crest of the culvert deck.
- Where possible, crossings of streams will be constructed at right angles to the flow and in locations where the channel is straight and has well defined banks.

Crossings will be covered with a non-erodible material such as rock or gravel and the upstream and downstream batters will be armoured with rock to control erosion caused by overtopping flows.

Figure 6.5 shows the preferred arrangement of a temporary culvert crossing in a minor stream with low gradient overbank areas. Figure 6.6 shows a single cell culvert placed within a constricted channel with steep overbank slopes.

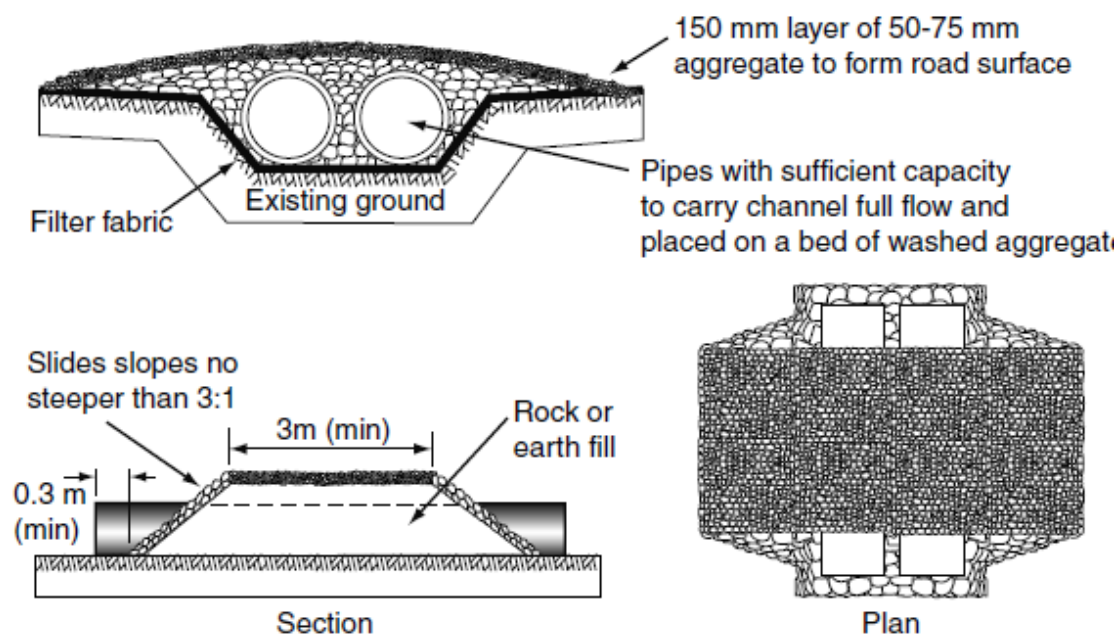

Figure 6.5 Typical temporary culvert crossing in a minor stream with low-gradient overbanks (IECA, 2008)

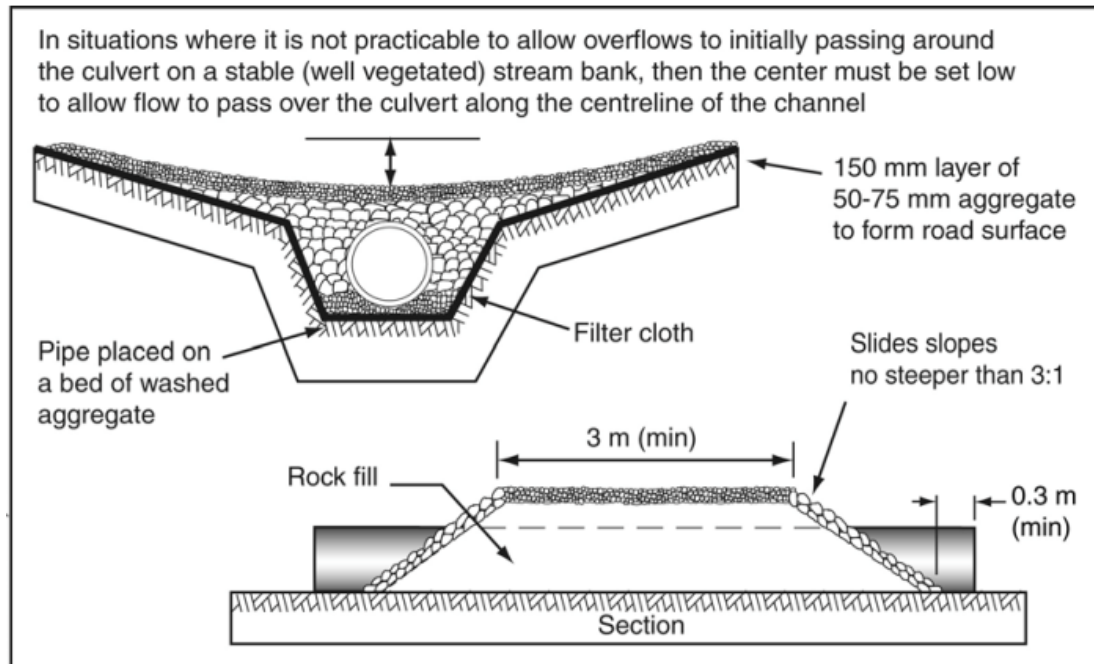
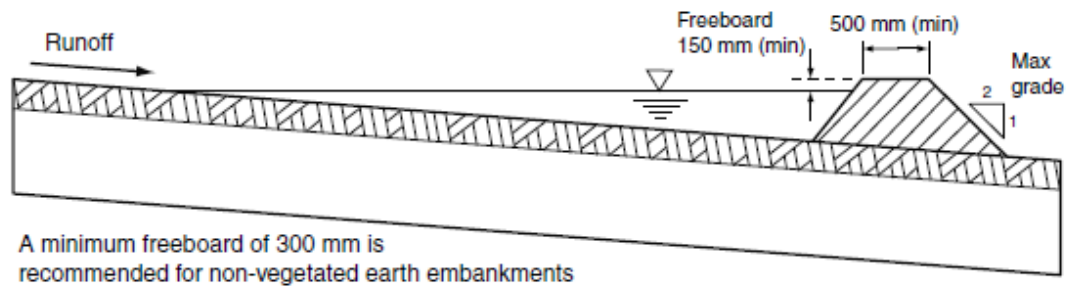

Figure 6.6 Typical temporary culvert crossing in a constricted channel with steep overbanks (IECA, 2008)

### 6.3.8 Typical configurations – Windrow

The configuration (dimensions) of each drain would be dependent on the upslope catchment area and slope. Upslope diverted water drains will be constructed as a diversion bank (windrow). This prevents excavation into material which may be dispersive. All upslope diverted water drains shall be vegetated, with additional drainage controls as required. Each drain typically contains the following features identified below and shown in Figure 6.7:

- vegetated earth embankment at least 0.5 m high with 0.5 m crest width;
- channel batters of at least 1(V):2(H), but preferably 1:4 (V:H);
- freeboard of at least 0.15 m above the design depth;
- where necessary check dams will be used to maintain peak velocity below the velocity limit;
- channel grades should not exceed 3%;
- drainage banks will be constructed to appropriate engineering standards;
- stable grass cover to be maintained in the bed and bank of the channel and below the channel outlets (as much as possible); and
- wherever practicable, avoid constructing drains through dispersive topsoil.



**Figure 6.7 Upslope diverted water configuration – diversion bank (IECA, 2008)**

### 6.3.9 Typical drain configurations - Channel

The configuration (dimensions) of each 'diverted' runoff drain would be dependent on the upslope catchment area and slope. Drain design can be broken into two categories of low flows and high flows based on the upslope catchment and slope of the drain. Each runoff drain typically contains the following features identified below and shown in Figure 6.8:

- trapezoidal channel;
- bank batters of between 1:2 (V:H) and 1:7 (V:H);
- channel batters at least 1(V):2(H), but preferably 1:4 (V:H);
- where necessary rock check dams will be used to maintain specified channel grades;
- channel grades should not exceed 5%;
- bank bottom widths (f) will vary depending on the adopted bank batters;
- diversion banks will be constructed to appropriate engineering standards.
- the channel outlet (level spreader) will be flared out to a minimum width of 1.5 x channel base width. Ground slopes below the channel outlet shall be less than or equal to the channel grade;
- stable grass cover to be maintained in the bed and banks of the channel and below the channel outlets (as much as possible); and
- wherever practicable, avoid cutting drains through dispersive soils. If a drain must be located through dispersive soils, the channel bed and banks will be treated or buried with non-dispersive soils (0.1m minimum cover) before placing any revegetation or channel liner.



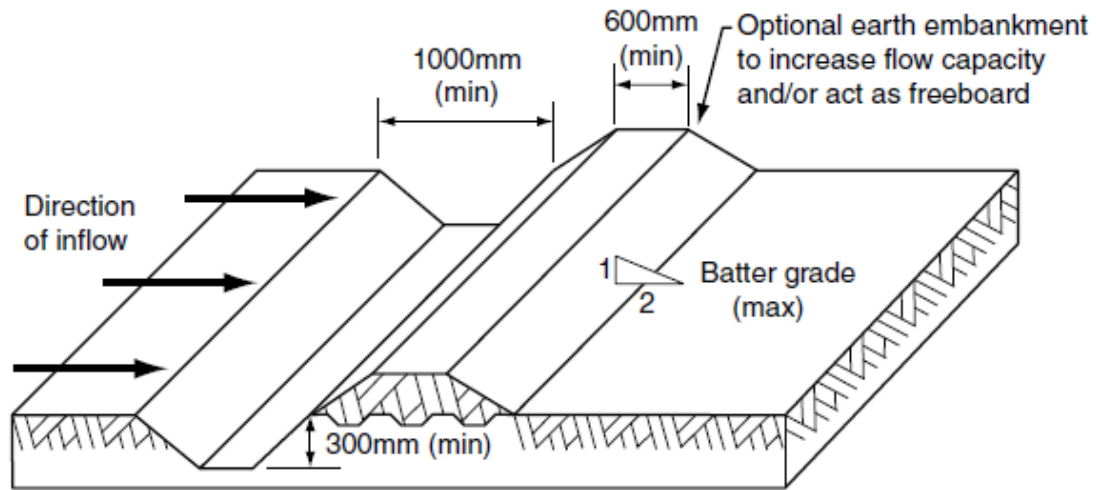

Figure 6.8 Typical drainage configuration - channel (IECA, 2008)

## 7 SEDIMENT CONTROL MEASURES

### 7.1 OVERVIEW

The primary function of sediment control measures is to trap the coarser sediment fraction. Sediment basins and some filtration systems used during dewatering operations are possibly the only sediment control techniques that have any significant ability to trap finer sediment particles such as silts or clays. Due to the difficulty of trapping these finer sediments, priority will be given to the use of effective erosion control measures wherever practical.

### 7.2 SEDIMENT CONTROL TECHNIQUES

#### 7.2.1 Primary controls

Primary control of sediment will be via sediment dams, designed and constructed in accordance with the Best Practice Erosion and Sediment Control guidelines (IECA, 2008). The sediment dam volumes will be based on the following design standards:

- A “Type D” sediment basin has been adopted.
- Total sediment basin volume = settling zone volume + sediment storage volume as shown in Figure 7.1. The sediment storage volume is the portion of the basin storage volume that progressively fills with sediment until the basin is de-silted. The settling zone is the minimum required free storage capacity that must be restored within 5 days after a runoff event.
- The settling volume is calculated based on the stormwater runoff from the catchment generated by an 80<sup>th</sup> percentile 5-day rainfall event.
- Sediment storage volume = 50% of settling zone volume.
- A depth of 2 m is adopted for the initial sizing of the sediment dams. The depth will be finalised in the detailed design of the sediment dams.

Indicative sediment dam sizing at the Project is listed in Appendix B (Table B.1).

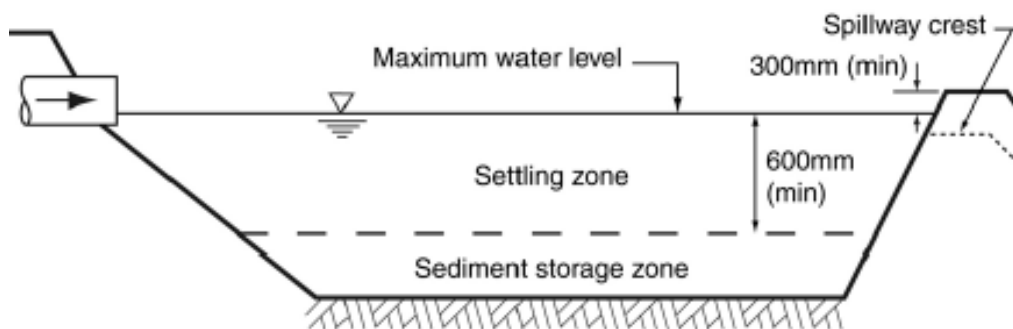

Figure 7.1 Typical type D sediment basin cross-section (Source: IECA, 2008)

### 7.2.2 Supplementary sediment control techniques

Supplementary sediment controls are used in areas where the sediment producing catchment is small or the potential for producing sediment laden runoff is low. A list of appropriate supplementary sediment control techniques is given in Table 7.1.

**Table 7.1 Summary of supplementary sediment control techniques**

Technique	Typical use
Rock filter dam	<ul style="list-style-type: none"> <li>• Locations where there is sufficient room to construct a relatively large rock embankment</li> <li>• The incorporation of a filter cloth is the preferred construction technique if the removal of fine grained sediment is critical (high maintenance)</li> </ul>
Check dam sediment trap	<ul style="list-style-type: none"> <li>• Supplementary sediment trap in minor concentrated flow areas</li> <li>• Trapping sediments in table drains and minor drainage lines</li> <li>• Check dams may be constructed of rock, sand bags or compost filled socks</li> </ul>
Buffer zones/ grass filter strips	<ul style="list-style-type: none"> <li>• Mostly suited to sandy soils</li> <li>• Can provide some degree of turbidity control while the buffer zone remains unsaturated</li> </ul>
Sediment fence	<ul style="list-style-type: none"> <li>• Supplementary device for sheet flow from minor catchment areas</li> <li>• Suitable for all soil types</li> <li>• Require maintenance after every runoff event</li> </ul>



---

## 8 ESC PLAN

### 8.1 ESC DECISION PROCESS

The following outlines the steps required to determine the applicable ESC techniques:

Identify the need for erosion, drainage and/or sediment control;

Define the land disturbance associated with where the control measure will be implemented;

Note the priority according to the matrix (Table 8.1) – this may be helpful in assessing which control technique to construct first;

What is the erosion potential at the location where the control measure will be implemented (Section 4.4);

Apply the ESC matrix (Section 8.4 – Table 8.2) to determine which erosion, drainage and sediment control techniques are applicable;

Use IECA (2008) to assess technical requirements of the selected techniques to make an informed decision as to the most appropriate erosion, drainage or sediment control technique to construct;

Prepare a plan of the area identifying the adopted techniques and document the measures within GIS that shows the following information:

significant landmark/project boundary;

general soil description;

existing and final contours - including location of cut and fill banks;

existing and final overland flow drainage paths;

limits of clearing where applicable;

location of vegetated buffer strips;

stabilised entry and exist points (rumble pad);

location of soil stockpiles;

location of all proposed temporary drainage control measures;

location of all proposed erosion and sediment control measures including installation sequence and maintenance requirements;

permanent site stabilisation measures; and

a statement of who is responsible for establishing and maintaining all erosion and sediment control measures.

Implement maintenance requirements and inspection regime (Section 9.4).

### 8.2 ESC CRITERIA

The decision as to which combination of ESC measures will be adopted lies with the Mine Site General Manager with input from the site team. The decision will be based on several factors as follows:

- site topography;
- material / soil / surface / strata type – where the control measure will be implemented and downstream of the control measure;

- current disturbance category;
- site specific constraints e.g. proximity of local watercourse;
- length of time that area will remain at this disturbance category;
- overall purpose of implementing ESC at a particular location; and
- applicability of ESC measure as per ESC Matrix.

The selection criteria that will be applied when choosing the most appropriate ESC measure(s) are (refer IECA, 2008):

- applicability to the full range of site conditions considered reasonable (construction phase and operational phase of ESC measure);
- availability of materials from onsite operations;
- cost-effectiveness based upon overall life of the work involved; and
- durability in relation to hydraulic and structural design during the life of the control measure performance in relation to purpose and control standard requirements.

### **8.3 ESC HAZARD ASSESSMENT**

Table 8.1 shows a hazard assessment of the environmental aspects and impacts of the land uses at the Project. The risk rating of each land use determines the ESC control measures that can be implemented to control drainage, erosion and sediment for each land use type shown in Table 8.2. Note the risk rating for each land use in Table 8.1 has been adopted as the priority rating in Table 8.2.

### **8.4 ESC MATRIX**

Table 8.2 shows a matrix of land uses and ESC measures developed to assist in determining which ESC measure is applicable.

This tool for selecting appropriate ESC measures is based on:

- the phase of the mine site (operational, non-operational or construction);
- land use type (specific to mining applications), adjacent land usage / classification and proximity to watercourses; and
- level of priority in providing ESC measures.

Where multiple ESC measures can be applied to the same situation, the Mine Site General Manager will be consulted. The decision should refer to the factors noted above in Sections 5, 6 and 7.

Once an ESC measure has been selected from the matrix, reference can be made to the IECA (2008) guidelines, which summarise design aspects for each of the ESC measures.

### **8.5 INSTALLATION SEQUENCE**

1. Establish the entry and exit points;

Divert upslope catchment around the work site and appropriately stabilise any drainage channels;

Install primary sediment control structures;

Construct drainage controls (and secondary sediment control structures if required) along the low side of the work site to the primary sediment control structure;

Clear only areas needed for works to occur;

Stockpile soil within the sediment-controlled area;



Stabilise exposed earth with erosion control structures;  
Commence works;  
Maintain all control structures in good working order; and  
Revegetate or otherwise stabilise the site.



**Table 8.1 ESC hazard assessment for land uses at the Project**

Sources/Domains	Environmental Aspects	Environmental Impacts	Risk
Spoil pile - draining externally	Erosion potential due to exposure and no vegetation cover, potential for material transport offsite	Mobilisation of sediment into waterways resulting in reduction in waterways water quality	HH
Spoil pile - draining internally	Erosion potential due to exposure and no vegetation cover	Inadequate sediment controls prior to release offsite could impact waterways water quality	M
Spoil pile - topsoiled	Erosion potential due to exposure and no vegetation cover, potential for material transport offsite	Mobilisation of sediment into waterways resulting in reduction in waterways water quality	H
Spoil pile – topsoiled/ripped/seeded	Erosion potential due to exposure and no vegetation cover, potential for material transport offsite	Mobilisation of sediment into waterways resulting in reduction in waterways water quality	M
Land clearing	Erosion of topsoil/subsoil surfaces where the material is exposed due to overland flow	Mobilisation of sediment into waterways resulting in reduction in waterways water quality	M
Soil stripping area	Erosion of topsoil/subsoil surfaces where the material is exposed due to overland flow	Mobilisation of sediment into waterways resulting in reduction in waterways water quality	H
Topsoil stockpile	High erosion potential due to lack of vegetation cover and negligible to highly dispersive soils. Potential for material transport offsite and loss of topsoil and subsoil material	Mobilisation of sediment into waterways resulting in reduction in waterways water quality. Loss of topsoil, impacting rehabilitation success	HH
Exploratory and access tracks	Erosion of topsoil/subsoil surfaces where the material is exposed	Mobilisation of sediment into waterways resulting in reduction in waterways water quality	M
Exploration activity	Erosion of topsoil/subsoil surfaces where the material is exposed	Mobilisation of sediment into waterways resulting in reduction in waterways water quality	M
Haul roads	Erosion of engineered earthworks due to overland flow, potential build-up of fine-grained material due to transport and traffic	Mobilisation of sediment into waterways resulting in reduction in waterways water quality	H
Industrial areas	Limited erosion due to hardstand surface, potential for build-up of fine-grained material due to transport and traffic. Potential migration of hydrocarbon and chemical substances into dams	Mobilisation of sediment and potentially hydrocarbon and chemical substances which could contaminate ESC structures and downstream waterways	HH

Sources/Domains	Environmental Aspects	Environmental Impacts	Risk
Drainage channels	Erosion of engineered earthworks due to concentrated flow. Build-up of sediment from previous flow events	Potential erosion/gullyng of structure due to water volume, potential to impact ESC storage capacity. Mobilisation of sediment into waterways resulting in reduction in waterways water quality	H
Licensed stream diversions / levees	Erosion of engineered earthworks due to concentrated flow, build-up of sediment from previous flow events	Potential erosion/gullyng of structure due to water volume. Mobilisation of sediment into waterways resulting in reduction in waterways water quality	HH
Construction / excavation work	Erosion of topsoil/subsoil surfaces where the material is exposed due to overland flow	Mobilisation of sediment into waterways resulting in reduction in waterways water quality	M

**Table 8.2 ESC Matrix**

ID	Phase (O = Operational; N = Non-operational; C=Construction)	Land use type	ESC Priority (L= low, M = Medium, H = High, HH = top priority)	Drainage Control			Erosion Control							Sediment Control								
				Catch Drains	Check Dams (incl. fibre ...)	Grass	Cellular Confinement	Hard Armouring	Rock Mattress	Rock Lining	Level Spreader	Rock Protection	Cellular Confinement	Compost Blanket	Gravelling	Mulching	Revegetation	Rock Mulch	Soil Binders	Rock Filter Dam	Check Dam Sed. Trap	Sediment Basin
1	O	Spoil - Draining Externally	HH	✓							✓	✓	✓	✓	✓	✓	✓	✓	✓	✓	✓	✓
2	O	Spoil - Draining Internally	M	✓	✓									✓			✓	✓	✓			✓
3	O	Spoil Topsoiled (to be revegetated)	H	✓	✓									✓	✓		✓	✓	✓	✓	✓	✓
4	O	Spoil Topsoiled, ripped and seeded	M	✓	✓	✓											✓	✓	✓	✓	✓	✓
5	O	Topsoil stripping area	M	✓	✓									✓			✓	✓	✓	✓	✓	✓
6	O	Topsoil Stockpiles	HH	✓	✓	✓						✓	✓	✓	✓		✓	✓	✓	✓	✓	✓
7	O	Exploratory and access tracks	M	✓	✓	✓	✓			✓		✓	✓	✓	✓	✓	✓	✓			✓	✓
8	O	Haul Roads	H	✓	✓	✓	✓	✓	✓	✓		✓					✓	✓	✓	✓	✓	✓
9	O	Industrial Areas	HH	✓	✓	✓	✓	✓	✓	✓		✓	✓	✓	✓		✓	✓	✓	✓	✓	✓
10	N	Exploration Activity	M	✓	✓	✓	✓			✓		✓	✓	✓	✓		✓	✓			✓	✓
11	C	Land clearing (woody vegetation)	M	✓	✓					✓				✓			✓			✓	✓	✓
12	O	Drainage channels	H	✓	✓	✓	✓	✓	✓	✓							✓					
13	N	Licenced stream diversions / Levees	HH			✓	✓	✓	✓	✓					✓	✓						
14	C	Construction / excavation work	M	✓	✓	✓	✓	✓	✓	✓	✓	✓	✓	✓	✓	✓	✓	✓		✓	✓	✓



## 8.6 MAINTENANCE REQUIREMENTS

Maintenance and routine inspection will be undertaken as follows:

- Prior to 1 November each year (prior to onset of wet season); and
- After each significant rainfall event that may have impacted the functionality of the ESC measure.

## 8.7 ESC INVENTORY REGISTER

An asset register database will be prepared for all ESC structures at the mine site. These assets will be located in a GIS map and a unique identification number (asset number) will be given to them. An inspection proforma template (Appendix C) will be used yearly to assess the condition of all ESC structures on site. Each ESC catchment will have its own inspection template which details the conditions of each control and any actions required.

## 9 MONITORING AND EMERGENCY REPORTING

### 9.1 OVERVIEW

This section of the ESCP provides an overview of the surface water monitoring program to assess compliance with the *Model mining conditions* (DES, 2017) in accordance with the WMP. Surface water monitoring locations for the Project are shown in Figure 9.1 and Figure 9.2. Figure 9.3 shows the process flowchart of the surface water monitoring, investigation and management measures for the Project.

The surface water quality monitoring points have been designated as upstream and downstream monitoring points in Table 9.1 which includes receiving waters locations for the drainage lines and watercourses crossing the Project. The table also gives the previous and current station id for the monitoring points. Table 9.2 gives the monitoring locations for the mine affected water storages.

Upstream monitoring points will be used to determine the water quality of natural surface waters that enter the mine site.

Downstream monitoring points will be used to assess the water quality of the receiving waters in the context of the Project by comparing the water quality to the site specific guideline value (SSGVs) and upstream sites. Once the Project commences operations within the downstream monitoring point catchments, these sites will be monitored directly after release events to assess the effect of Project releases.

Monitoring will be undertaken by a suitably qualified person in accordance with the methods prescribed in the latest edition of the administering authority's *Monitoring and Sampling Manual* (DES, 2018).

**Table 9.1 Surface water monitoring locations (Table F2 of EA)**

Station ID	Previous Station ID	Catchment Area	Latitude (GDA 2020)	Longitude (GDA2020)	Description
<b>Upstream sites</b>					
DL2_US	N/A	Boomerang Creek	22.290841264°S	148.154357187°E	Drainage line 2 upstream of the highwall trial mining area
DL3_US	N/A	Boomerang Creek	22.305612596°S	148.192716185°E	Drainage line 3 upstream of the haul road
DL4_US	N/A	Boomerang Creek	22.323035473°S	148.200252458°E	Drainage line 4 at the upstream mining lease boundary
DL6_US	N/A	East Creek	22.339508200°S	148.207957289°E	Drainage line 6 at the upstream mining lease boundary
DL7_US	N/A	East Creek	22.347211456°S	148.209392813°E	Drainage line 7 at the upstream mining lease boundary
HCN_US	N/A	Hughes Creek	22.370485469°S	148.226638033°E	Hughes Creek north tributary approximately 5.5 km upstream of Saraji Road
HC_US	VSW5	Hughes Creek	22.395927439°S	148.224656137°E	Hughes Creek approximately 2.8 km upstream of Saraji Road

DL8_US	N/A	Hughes Creek	22.395784122°S	148.251629364°E	Drainage line 8 approximately 2.2 km upstream of Saraji Road
BC1_US	VSW6	Hughes Creek	22.411388907°S	148.269449617°E	Barrett Creek upstream of Saraji Road
<b>Downstream sites</b>					
DD1_US	VSW1	Boomerang Creek	22.276596290°S	148.174514955°E	Diversion bund
DD1_DS	VSW2	Boomerang Creek	22.301050508°S	148.195240117°E	Drainage line 2, downstream of the confluence of existing diversion drain
DL2_DS	VSW11	Boomerang Creek	22.298264498°S	148.189625245°E	Drainage line 2 upstream of confluence of existing diversion drain
DL3_DS	VSW3	Hughes Creek	22.306311857°S	148.194663612°E	Minor drainage line, upstream of confluence of Drainage Line 2
DL4_DS	VESW4	Hughes Creek	22.321553686°S	148.200307744°E	Drainage line 4 upstream of the confluence of Boomerang Creek
DL6_DS	VSW9	East Creek	22.334779125°S	148.221868903°E	Drainage line 6, at the downstream mining lease boundary
DL7_DS	VSW7	East Creek	22.343101091°S	148.231039608°E	Drainage line 7, at the downstream mining lease boundary
HC_DS	VSW4	Hughes Creek	22.384885209°S	148.266275740°E	Hughes Creek at the downstream mining lease boundary
DL8_DS	VSW10	Hughes Creek	22.388240114°S	148.268093290°E	Drainage line 8 at the downstream mining lease boundary

**Table 9.2 Mine affected water storages (Table F4 of the EA)**

Station ID	Latitude (GDA2020)	Longitude (GDA2020)	Description	Frequency
MWD6	22.364255447°S	148.227496324°E	MWD6 spillway	Quarterly
MWD7	22.361502986°S	148.230735154°E	MWD7 spillway	Quarterly
MWD8	22.364977354°S	148.229969352°E	MWD8 spillway	Quarterly
MWD9	22.376445088°S	148.251660294°E	MWD9 spillway	Quarterly

## 9.2 MONITORING AND ESC SCHEDULE

Table 9.3 summarises the indicative schedule of the ESC structures, levees and clean water drains (shown in Figure 1.3 to Figure 1.8) and their respective upstream and downstream monitoring locations. Monitoring will commence at the upstream and downstream monitoring locations 2 months prior to any planned disturbance in the catchment.



All sediment control structures, including but not limited to, sediment dams, drains and levees will be constructed/in place prior to any upstream disturbance, clearing, construction or any mining activities within their respective catchments.

**Table 9.3 ESC structure schedule**

ESC Structure	Proposed operational years	Schedule of commencement of monitoring	Upstream monitoring point	Downstream monitoring point
SD9	2025 to 2026		DL7_US	DL7_DS
SD10	2025 to 2026		DL7_US	DL7_DS
SD11	2025 to 2026		DL7_US/DL6_US*	DL6_DS
SD12	2025 to 2026	Prior to construction in 2025	DL7_US	DL7_DS
SD13	2025 to 2026		DL7_US/DL6_US*	DL6_DS
SD14	2025 to 2026		DL7_US/DL6_US*	DL6_DS
SD15	2025 to 2026		DL7_US/DL6_US*	DL5_DS
SD16	2025 to 2032		HCN_US, HC_US	HC_DS
SD17	2025 to 2032		HCN_US, HC_US	HC_DS
SD18	2025 to 2032	Prior to construction in 2025	HCN_US, HC_US	HC_DS
SD19	2025 to 2032		HCN_US, HC_US	HC_DS
SD20	2025 to 2032		HCN_US, HC_US	HC_DS
SD21	2029 to 2032		HCN_US, HC_US	HC_DS
SD22	2029 to 2032		HCN_US, HC_US	HC_DS
SD23	2029 to 2032		HCN_US, HC_US	HC_DS
SD24	2029 to 2032		DL8_US, HC_US	HC_DS
SD25	2029 to 2032	Prior to construction in 2029	DL8_US, HC_US	HC_DS
SD26	2029 to 2032		DL8_US, HC_US	HC_DS
SD27	2029 to 2032		DL8_US, HC_US	HC_DS
SD28	2029 to 2032		DL8_US, BC1_US	DL8_DS
SD29	2029 to 2032		DL8_US, BC1_US	HC_DS
SD30	2029 to 2032		HCN_US, HC_US	HC_DS

HWD1	2025 to 2026	Prior to construction in 2025	DL2_US	DL2_DS
Vulcan North Levee	2025 to 2026	Prior to construction in 2025	DL7_US	DL7_DS
Vulcan Main Levee 2	2025 to 2032	Prior to construction in 2025	HCN_US, HC_US	HC_DS
Vulcan Main Levee 1	2029 to 2032	Prior to construction in 2029	HCN_US, HC_US	HC_DS
Vulcan South Levee	2029 to 2032	Prior to construction in 2029	DL8_US, BC1_US	DL8_DS
DL6a	2025 to 2032	Prior to construction in 2025	DL7_US/DL6_US*	DL6_DS
DL8a	2029 to 2032	Prior to construction in 2029	DL8_US	DL8_DS
CD01a	2029 to 2032	Prior to construction in 2029	HC_US	HC_DS

Note: \*DL6\_US can be used as an upstream monitoring site once the Drainage line 6 catchment is no longer diverted

## 9.3 SURFACE WATER

### 9.3.1 Water quantity

The volumes of overflows from sediment dams can be estimated from the level and duration of overflow. Flow in Drainage line 6 is to be measured using a stream gauge at monitoring point DL6\_DS shown in Figure 9.1.

### 9.3.2 Release to receiving waters

The following conditions of the EA, P-EA-100265081 are to be satisfied in relation to the release to the receiving waters:

- Condition F1 - Contaminants must not be released to any waters unless otherwise permitted by the environmental authority.
- Condition F2 – Mine affected water must not be released directly or indirectly to the receiving environment.
- Condition F3 – Surface water runoff is permitted to be released to waters for the purpose of ensuring stormwater does not become mine affected water from:
  - Erosion and sediment control (ESC) structures identified in Table 9.4 that are installed and operated in accordance with the ESCP if monitoring required by condition F4 confirms that water quality is compliant with the sediment dam trigger values specified in Table 9.5; and
  - water management infrastructure that is installed and operated, in accordance with a Water Management Plan that complies with condition F24.

### 9.3.3 Water quality

Surface water quality monitoring includes onsite water storages, receiving water and release water monitoring on both a rainfall event and monthly basis. The event-based sampling enables quantification of any pollutant loads from the site and their corresponding impact on the receiving water quality. The locations of the monitoring sites are shown in Figure 9.1 and Figure 9.2 and will be undertaken within 2 hours of a release event. Samples will be taken from the following locations:

- Sediment dam release locations as shown in Table 9.4;
- Mine affected water monitoring locations as shown in Table 9.2; and

- Receiving water sites located upstream and downstream of the Project area to assess the potential impact of the project on the existing environment as shown in Table 9.1.

According to Condition F4, the water from ESC structures must be monitored at the release locations detailed in Table 9.1 for each quality characteristic, and at the frequencies, specified in Table 9.4 (from Table F3 of the EA). In the event that water quality is above the trigger level on three consecutive occasions, an investigation on the cause of the exceedance will be undertaken in accordance with Condition F6 of the EA.

Per condition F5 of the EA, if monitoring of any ESC structure identifies an exceedance of any of the sediment dam trigger values identified in Table 9.5 (Table F3 of the EA), all water in the structure that has exceeded the trigger values will be transferred to a storage listed in Table 9.2 (Table F4 of the EA).

**Table 9.4 ESC structure monitoring locations (Table F1 of the EA)**

Storage name	Latitude (GDA2020)	Longitude (GDA2020)	ESC structure water source location	Downstream monitoring point	Receiving waters description
SD9	-22.3432	148.2276	Vulcan North Out of Pit Dump	DL7_DS	Drainage Line 7
SD10	-22.3469	148.224	Vulcan North Out of Pit Dump	DL7_DS	Drainage Line 7
SD11	- 22.3379	148.2193	Vulcan North In Pit Dump	DL6_DS	Drainage Line 6
SD12	-22.3418	148.2297	Vulcan North In Pit Dump	DL7_DS	Drainage Line 7
SD13	-22.3353	148.2226	Vulcan North In Pit Dump	DL6_DS	Drainage Line 6
SD14	-22.3341	148.2203	Vulcan North In Pit Dump	DL6_DS	Drainage Line 6
SD15	-22.3315	148.2157	Vulcan North Out of Pit Dump	DL5_DS	Drainage Line 5
SD16	-22.3643	148.2365	Vulcan North Out of Pit Dump	HC_DS	Hughes Creek
SD17	-22.3578	148.2441	Vulcan Main In Pit Dump	HC_DS	Hughes Creek
SD18	-22.3612	148.2469	Vulcan Main In Pit Dump	HC_DS	Hughes Creek
SD19	-22.3737	148.2488	Vulcan Main In Pit Dump	HC_DS	Hughes Creek
SD20	-22.3682	148.2532	Vulcan Main In Pit Dump	HC_DS	Hughes Creek
SD21	-22.3738	148.2582	Vulcan Main In Pit Dump	HC_DS	Hughes Creek
SD22	-22.3782	148.2617	Vulcan Main In Pit Dump	HC_DS	Hughes Creek
SD23	-22.3784	148.257	Vulcan Main In Pit Dump	HC_DS	Hughes Creek

Storage name	Latitude (GDA2020)	Longitude (GDA2020)	ESC structure water source location	Downstream monitoring point	Receiving waters description
SD24	-22.3852	148.2658	Vulcan Main In Pit Dump	HC_DS	Hughes Creek
SD25	-22.3875	148.2673	Vulcan Main In Pit Dump	HC_DS	Hughes Creek
SD26	-22.3888	148.2676	Vulcan Main In Pit Dump	HC_DS	Hughes Creek
SD27	-22.3914	148.2636	Vulcan South Out of Pit Dump	HC_DS	Hughes Creek
SD28	-22.4011	148.2697	Vulcan South Out of Pit Dump	DL8_DS	Barrett Creek
SD29	-22.3944	148.271	Vulcan South In Pit Dump	HC_DS	Hughes Creek
SD30	-22.3818	148.2641	Vulcan South In Pit Dump	HC_DS	Hughes Creek
HWD1	-22.2866	148.1497	Highwall Trial Area Bench	DL2_DS	Drainage Line 2

**Table 9.5 Contaminant trigger investigation levels (from Table F3 of the EA)**

Quality characteristic (units)	Sediment dam trigger value	Downstream monitoring point trigger value	Source	Frequency
pH	6.5-8.5	6.5-8.5	EPP WQO (aquatic ecosystems)	Monthly and
Electrical Conductivity (µS/cm)	864*	Baseflow: 720 Medium flow: 500 High flow: 250	EPP WQO	Daily during release (the first sample must be taken within 2 hours of commencement of release)
Turbidity (NTU)	60*	50	EPP WQO	
Total Suspended Solids (mg/L)	102^	85	EPP WQO	
Sulphate as SO4 (mg/L)	37#	25	EPP WQO	
Ammonia (µg/L)	900	900	ANZG 2018	
Nitrate (µg/L)	1,100	1,100	For aquatic ecosystem protection, based on ambient Qld WQ Guidelines (2006) for Total Nitrate	
<b>Filtered metals and metalloids</b>				
Aluminium (µg/L)	192*	160	Locally derived	Monthly and
Arsenic (µg/L)	16*	13	ANZG 2018	



Lead (µg/L)	4.1*	3.4	ANZG 2018	Commencement of release and thereafter weekly during release
Mercury (µg/L)	0.72*	0.6	EPP WQO (aquatic ecosystems)	
Molybdenum (µg/L)	40.8*	34	EPP WQO (aquatic ecosystems)	
Selenium (µg/L)	6*	5	ANZG 2018	

**Note:**

All metals and metalloids must be measured as 'dissolved' (from analysis of a field filtered sample) and total (unfiltered). Limits for metals and metalloids apply to dissolved results.

\*20% increase on trigger value

# 95th percentile site specific

^locally derived trigger values (80th percentile values of natural surface water monitoring)

## 9.4 MAINTENANCE AND INSPECTIONS

### 9.4.1 ESC structures and clean water drains

In accordance with IECA (2008) all ESC measures will be inspected as follows:

- at least daily when rain is occurring;
- within 24 hours prior to expected rainfall; and
- within 2 hours of a rainfall event of sufficient intensity and duration to cause on-site runoff.

Daily site inspections taking place during periods of runoff inducing rainfall must check:

- all drainage, erosion and sediment control measures;
- occurrences of excessive sediment deposition (whether on-site or off-site); and
- all site discharge points.

Site inspections immediately prior to anticipated runoff inducing events must check:

- all drainage, erosion and sediment control measures; and
- all temporary (i.e. overnight) flow diversion and drainage works.

Site inspections immediately following runoff producing rainfall must check:

- treatment and dewatering requirements of sediment basins;
- sediment deposition within sediment basins and requirements for its removal;
- all drainage, erosion and sediment control measures;
- occurrences of excessive sediment deposition (whether on-site or off-site);
- occurrences of construction materials, litter or sediment placed, deposited, washed or blown from the site, including deposition by vehicular movements; and
- occurrences of excessive erosion, sedimentation, or mud generation around the site office, car park and/or material storage area.

In addition to the above, monthly site inspections must check:

- surface coverage of finished surfaces (both area and percentage cover);
- health of recently established vegetation; and

- proposed staging of future land clearing, earthworks, pre-strip activities and site/soil stabilisation.

The inspection and monitoring regime will collect and record the following key information:

- the previous condition of the infrastructure and any recommendations or works actioned since the last inspection;
- the current condition of the ESC infrastructure;
- the ESC controls currently in place, and their condition; and
- recommendations on remedial measures or additional ESC controls.

Any failure of effectiveness of structure will be reported to the Mine Site General Manager. The implementation plan will include the recommendations for the incident report. An example inspection template is shown in Appendix C.

#### 9.4.2 Levee monitoring

Inspection of flood protection levee must be undertaken to ensure the design, construction, operation and maintenance for the levee is appropriate for the materials used and the levee's intended function and will be carried out as follows (International Levees Handbook, CIRIA, 2013):

- **Initial inspections** should evaluate and document the condition of the entire levee soon after construction. The initial inspection helps to determine the existing system's capability of the existing system to perform satisfactorily under full hydraulic loading. Initial inspections should document all aspects of the levee system to set a baseline understanding for the condition of the overall levee system.
- **Routine inspections** should provide documented evidence that the levee continues to meet minimum acceptable standards for operations and maintenance, which relate to acceptable performance levels. Routine inspections are normally performed on a regular basis, for example once per year.
- **'Inflow' inspections** are performed while the system is loaded and are extremely valuable in identifying weak or susceptible areas that could lead to a potential future failure. These inspections could lead to planning emergency repairs and/or initiating population evacuation. In-flood inspections should only be undertaken if they can be done safely.
- **'Post-flood' inspections** are crucial in observing any damage which may have occurred and in evaluating the levee's ability to withstand a future loading event. This type of inspection is also used to validate, verify and to add to information collected during the flood event, and could identify the need for urgent remedial work.

During operations, the following should be undertaken at least once every year:

- Regular maintenance for each defined component of the levee/levee system, such as mowing of batters, checking and cleaning of drainage systems, testing of valves, pumps, etc, testing of demountable items (e.g. drop bars, gates), etc.
- A general visual inspection of the system once a year (as a minimum), undertaken by someone with experience in the techniques used in the construction of the levee and associated works.
- Follow-up activities on issues identified by the general visual inspection (e.g. removal of saplings, removal of rabbit burrows, repair of rilling and other weather erosion, repair of fencing, improved management of stock access, etc).
- Recording and entering into the asset management system of the above activities.

Remediation works will be undertaken where inspections identify the integrity of the levee has been affected by erosion or other failure mechanisms.

#### 9.4.3 Drainage line diversion monitoring

The drainage line diversions will be monitored regularly to collect data for use in evaluating their performance. The collection of monitoring data will help identify any issues with the construction of the diversion and assist with relinquishment of the diversion at mine closure. The monitoring plan will be carried out for three reaches (upstream of diversion, the diversion and downstream of diversion) in three different stages as follows:

- Baseline monitoring during operations will be used to provide a reference data set for evaluation of the landform diversions shown in Figure 1.11 and Figure 1.13 and will include:
  - site photography;
  - aerial photography;
  - survey;
  - vegetation characterisation and assessment; and
  - flow event monitoring
- During construction, monitoring will be conducted to ensure the diversion is constructed to the design specifications and will include:
  - execution database to record construction activities;
  - site photography; and
  - aerial photography.
- Operations monitoring will be conducted after construction works have been completed to maintain channel condition and to identify remedial works. The operations monitoring is a combination of visual assessments and survey data and will include:
  - survival of works;
  - site photography;
  - aerial photography;
  - visual assessment;
  - index of diversion condition (IDC);
  - site survey; and
  - flow events monitoring.

The intention is that the diversions will be stable and require minimal maintenance during mine operations. While erosion risks will require mitigation immediately post construction, it should ultimately achieve a state of dynamic equilibrium with the adjoining reaches such that ongoing management is not required post mining.

## 9.5 EMERGENCY RESPONSE

### 9.5.1 Overview

The proposed water management strategy for the Project has been developed for both normal operations and during extreme wet weather events in order to:

- minimise the risk of uncontrolled releases from mine-affected water dams; and

- ensure compliance with the *Model mining conditions* (DES, 2017) and the EA P-EA-100265081.

The emergency response plan for the site is managed in the Project Safety and Health Management System. A summary of the emergency response, should a failure of the water management strategy occur, is given below.

### 9.5.2 Uncontrolled releases

In the event of an uncontrolled release details of any contravention of a condition of the environmental authority must:

- a) be reported to the administering authority within twenty-four (24) hours of becoming aware of the contravention; and
- b) include the nature and circumstances of the contravention and any immediate actions taken.
- c) As soon as reasonably practicable an investigation report will be submitted to the administering authority detailing:
  - i. the potential circumstances and actions that may have contributed to the contravention; and
  - ii. reasonable and practicable measures that will be implemented to address the cause of the contravention to prevent future contraventions of this nature and to address any actual or potential environmental harm.

## 9.6 DAM MONITORING

The embankments of all dams will be monitored annually before the wet season, and during and after flow events to ensure they are operating satisfactorily and have not been damaged through erosion.

Should a dam become damaged, the stored water will be pumped to a suitable water storage facility to minimise the risk of an uncontrolled release to the downstream waterway. The Mine Site General Manager will be responsible for communicating with regulators. A suitably qualified person shall be used to inspect the dam. Repair work will occur as soon as practicable after damage has occurred.

## 9.7 WET WEATHER ACCESS

During wet weather, site access is restricted due to impassable dirt roads, flooding and safety issues. It is proposed that waterways which have short duration flows and are inaccessible in wet conditions have rising stage samples which can be used to take water samples, minimising exposure of personnel to extreme weather events.

## 9.8 POST-EVENT MONITORING

Dams and drains onsite will be inspected after any significant rainfall event where overflows from sediment dams occur. Drains and dam spillways will be checked for erosion damage and repaired when required.

## 9.9 AUDIT SCHEDULE

In addition to the routine maintenance inspections outlined in Section 8.6 and above, an overall audit of the ESCP will be undertaken by the Mine Site General Manager at least annually, following the wet season. The audit will be undertaken to ensure that all ESCP controls on site are being maintained and implemented as required by this ESCP.



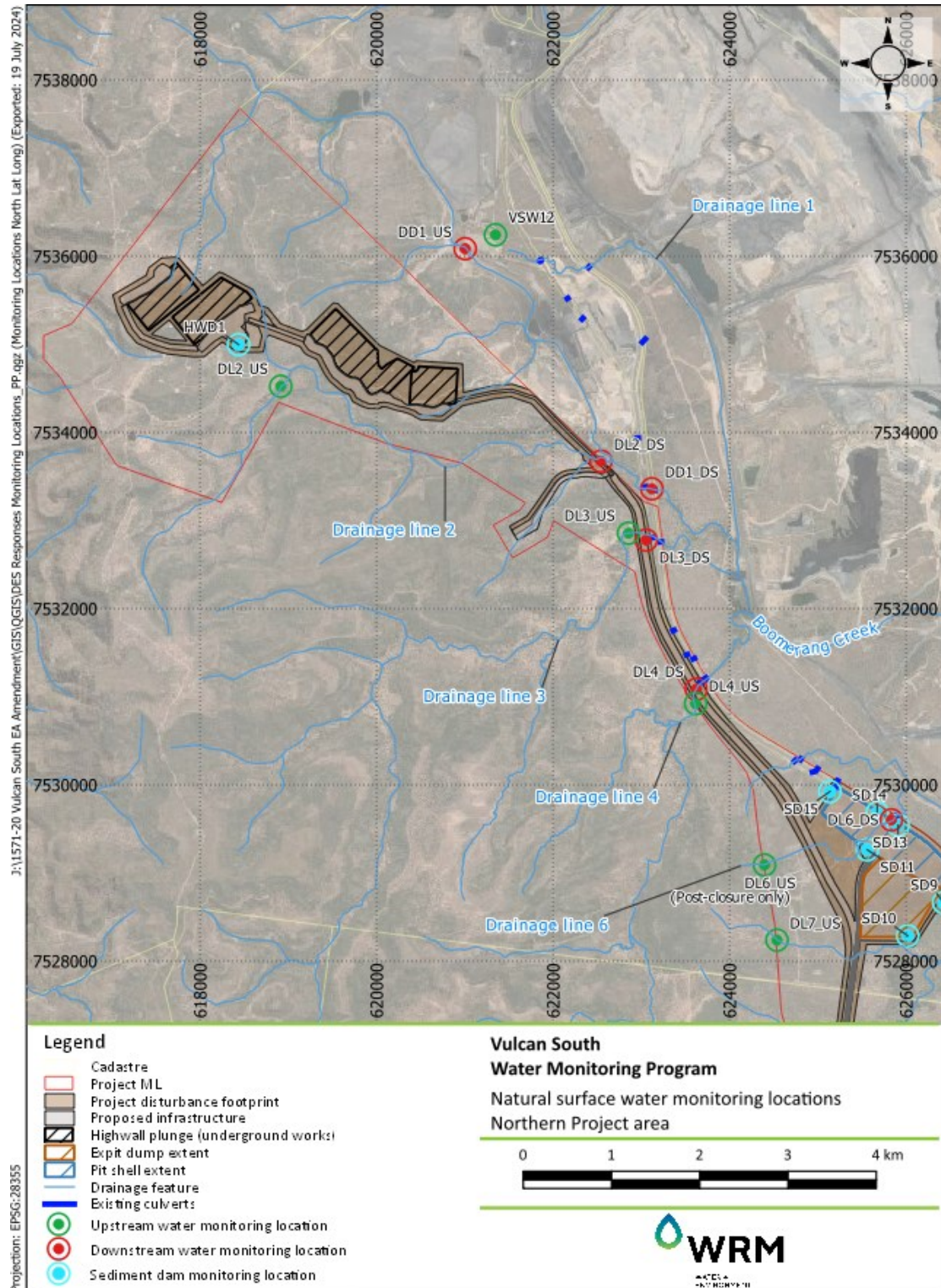

Figure 9.1 Vulcan South surface water monitoring locations – northern project area



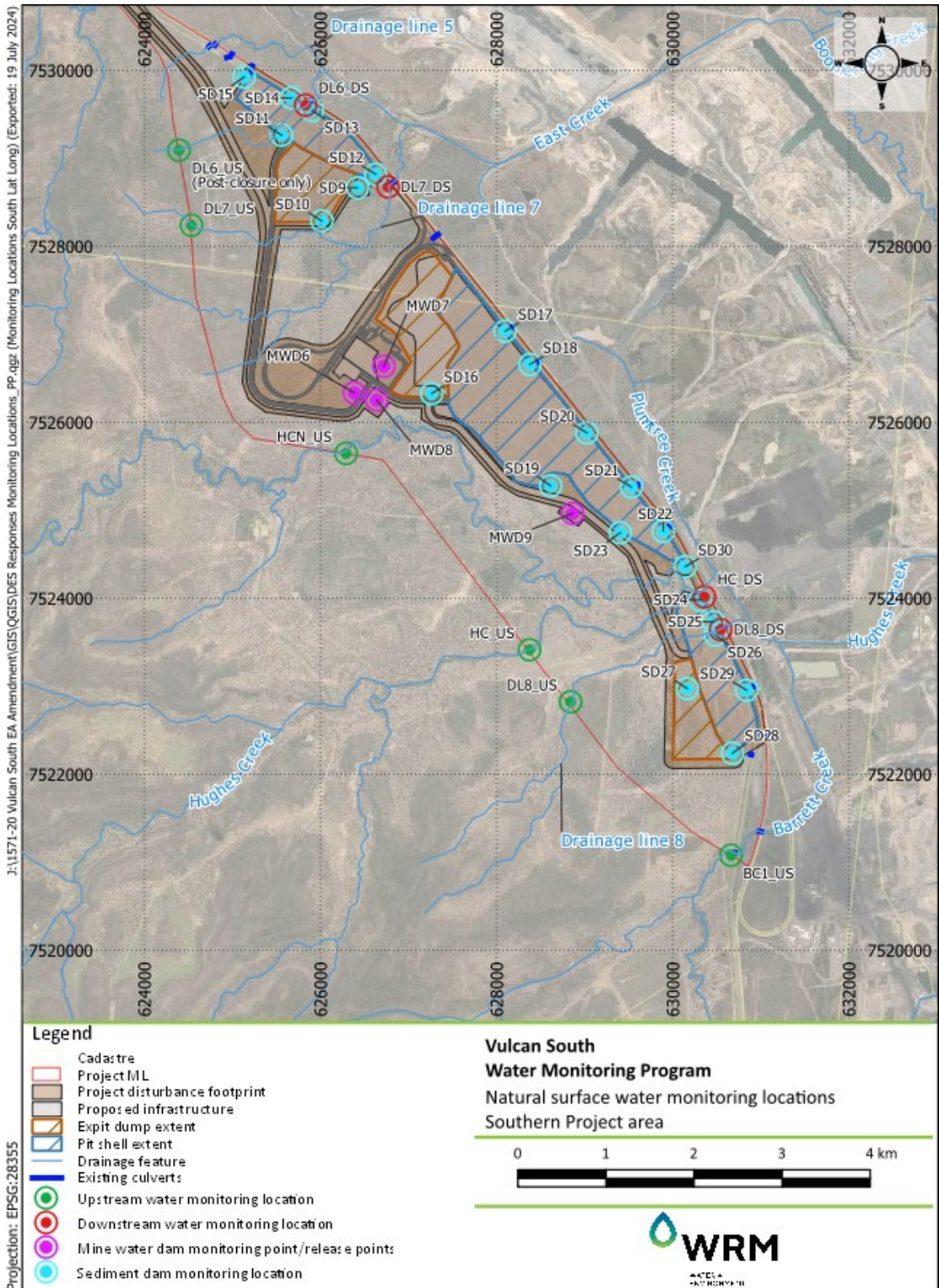

Figure 9.2 Vulcan South surface water monitoring locations – southern project area



Figure 9.3 Surface water monitoring, investigation and management flowchart

## 10 REFERENCES

AARC Environmental Solutions Pty Ltd, 2019	<i>Vulcan Project Soil and Land Suitability Assessment</i> . October 2019.
ANZECC & ARMCANZ, 2018	Australian and New Zealand Environment and Conservation Council - Agriculture and Resource Management Council of Australia and New Zealand, 2018, <i>Australian and New Zealand Guidelines for fresh and marine water quality</i> .
CIRIA, 2013	<i>International Levee Handbook (ILH)</i> , 2013.
DEHP, 2012	Queensland Government Department of Environment and Heritage Protection, July 2012, <i>'Preparation of Water Management Plans for Mining Activities'</i> .
DEHP, 2013	Queensland Government Department of Environment and Heritage Protection, July 2013, <i>'Queensland Water Quality Guidelines 2009'</i> , July 2013.
DES, 2013	Queensland Government Department of Environment and Heritage Protection, March 2013, <i>'Model water conditions for coal mines in the Fitzroy basin'</i> .
DES, 2017	<i>Model mining conditions guideline</i> . Effective 7 March 2017.
DES, 2021	<i>Reef discharge standards for industrial activities</i> , Effective 1 June 2021.
DSITI, 2017	Newham M, Moss A, Moulton D, Honchin C, Thames D, Shrestha K & Elledge A (2017). <i>Draft environmental values and water quality guidelines: Fitzroy Basin fresh, estuarine and marine waters, including Keppel Bay – March 2017</i> . Department of Science, Information Technology and Innovation, Queensland.
IECA, 2008	International Erosion Control Association (Australasia), November 2008. <i>'Best Practice Erosion and Sediment Control'</i> .
METServe, 2023	Mining Energy Technical Services Pty Ltd (METServe), October 2023. <i>'Environmental Authority Amendment Application – Supporting Information – Vulcan North Bulk Sample'</i> .
QLD Government, 2019	Environmental Protection (Water and Wetland Biodiversity) Policy 2019
WRM, 2023	WRM Water & Environment Pty Ltd, March 2023. <i>'Vulcan South Surface water assessment'</i> , report prepared for Vitrinite Pty Ltd.



## EROSION HAZARD ASSESSMENT (IECA, 2008)

### Appendix F

## Erosion hazard assessment

*This appendix provides example procedures for conducting an Erosion Hazard Assessment on a proposed land development. Its function within this document is both educational and prescriptive.*

### F1. Introduction

Erosion Hazard Assessment is a procedure for undertaking a “preliminary” assessment of the environmental hazard associated with the construction of a given land development. The assessment is based on the land development as a whole, and does not look at individual drainage catchments within the development. Erosion hazard within individual sub-catchments of a development can be assessed using soil loss prediction tools such as RUSLE, for more information refer to Appendix E – *Soil loss estimation*.

An erosion hazard assessment may be performed for a number of reasons, including:

- to identify those land developments that require a preliminary assessment of ESC issues during the planning phase;
- to identify those developments that require a review of the Erosion and Sediment Control Plan (ESCP) by an ESC specialist, such as a Certified Professional in Erosion and Sediment Control (CPESC), an accreditation system administered by the International Erosion Control Association (IECA).

As an example, proponents of developments assessed as high-risk may be required to:

- submit a draft ESCP during the development planning phase;
- submit to the regulatory authority the results of specific soil testing;
- have their final ESCP reviewed by an ESC specialist.

Two methods for assessing the Erosion Hazard are provided within this appendix. Regulatory authorities may choose either system, or an alternative system that better satisfies their needs.

An alternative erosion hazard assessment form for small building sites is provided in Appendix H – *Building sites*.

#### Technical Note F1 – Erosion Hazard Assessment vs erosion risk rating

Erosion Hazard Assessment is different from the erosion risk rating systems introduced in Section 4.4 (Chapter 4 – *Design standards and technique selection*) of this document for the determination of the Erosion Control Standard. The adoption of an erosion risk rating system allows regulatory authorities to relate the Erosion Control Standard to either the estimated soil loss rate (i.e. RUSLE analysis), the monthly erosivity (i.e. monthly R-factor), or the average monthly rainfall depth.

The Erosion Control Standard can be linked to just the rainfall erosivity or monthly rainfall depth—without consideration of other factors such as surface area, land slope and soil type—because the focus is primarily on raindrop impact erosion rather than sheet and rill erosion. It is noted that the Sediment Control Standard is best linked to the estimated soil loss rate which considers both sheet and rill erosion rates.

## F2 TASK number erosion hazard assessment system

The following Erosion Hazard Assessment system is based on a modification of the Revised Universal Soil Loss Equation (RUSLE). The TASK number is directly proportional to the estimated total soil loss within a given region (i.e. for a given rainfall erosivity).

$$H = T \cdot A \cdot S \cdot K \quad (F1)$$

where:

- H = Numerical value of the TASK number
- T = Duration of soil disturbance [months]
- A = Total area of soil disturbance [m<sup>2</sup>]
- S = Slope factor (Table F2 or Equation F3)
- K = Soil erosivity factor (RUSLE K-factor)

The TASK number is used to identify low-risk and high-risk short-term land disturbances within a given region. Regulatory authorities may assign their own trigger value for high-risk sites, however, if a local trigger value has not been adopted, then a default value of 200 is recommended as per Table F1.

**Table F1 – Default high-risk trigger value**

Hazard Rating	Low-risk	High-risk
TASK Number	< 200	200 or greater

If at the planning stage it is possible to subdivide the soil disturbance area into sub-areas of near-uniform land slope, then the TASK number represents the sum of TASK values determined for each sub-area with soil erodibility K-factor values determined for each sub-area as per Equation F2.

$$\text{TASK Number} = \sum (T \cdot A \cdot S \cdot K) \quad (F2)$$

### T-factor:

The duration of disturbance refers to the total amount of time that the site will be exposed to potential rainfall for the duration of the construction project, or a given stage of the project (if known) up until a time when there is at least 70% vegetative cover, or 100% synthetic cover of all areas of disturbed soil.

In regions where seasonal rainfall is well defined, then the duration of exposure should not include those periods when rainfall is not considered likely to occur.

### A-factor:

Note: the A-factor used in the TASK number is **not** the same as the "A" term determined from a RUSLE analysis.

The total area of soil disturbance refers to the maximum area of the disturbance that will occur at any given time over the duration of the project. If at the planning stage it is not possible to determine the staging of works, then the area of disturbance must be taken as the total area of disturbance for all stages of the project.

Well-vegetated (protected) land not disturbed by the development project should not be included in the analysis.

**S-factor:**

The slope factor (S) is based on that land slope of which no more than 10% of the land is steeper. Values of the S-factor are provided in Table F2 and Equation F3. These values are based on the RUSLE's LS-factor for a slope length limited to the best management practice values presented in Table 4.3.2 of Chapter 4 – *Design standards and technique selection*.

**Table F2 – Slope factor**

Slope (%)	1%	2%	3%	4%	5%	6%	8%	10%	15%	20%	30%
<b>S-factor</b>	0.21	0.35	0.48	0.61	0.73	0.85	1.08	1.29	1.75	2.12	2.58

$$\text{S-factor} = 0.071 + 0.141 (\text{Slope } \%) - 0.0019 (\text{Slope } \%)^2 \quad (\text{F3})$$

**K-factor:**

The soil erodibility K-factor is the same as the term used in the RUSLE analysis. Preliminary soil testing (refer to Chapter 3 – *Site planning*) will be required to determine the soil classification group.

**Table F3 – Nominal K-factors based on Unified Soil Classification System**

Brief description	Code	Typical values	Default <sup>[1]</sup>
Silty gravels, poorly graded gravel-sand-silt	GM	0.00 – 0.06	0.053
Clayey gravels, poorly graded gravel-sand-clay	GC	0.00 – 0.05	0.042
Well graded sands, gravelly sands, little fines	SW	0.00 – 0.04	0.036
Poorly graded sands, gravelly sands, few fines	SP	0.00 – 0.03	0.027
Silty sands, poorly graded sand-silt mixtures	SM	0.01 – 0.05	0.043
Clayey sands, poorly graded sand-clay mixtures	SC	0.02 – 0.05	0.044
Inorganic silts, clayey sands with slight plasticity	ML	0.03 – 0.07	0.062
Inorganic clays of low to medium plasticity	CL	0.02 – 0.06	0.058
Organic silts and organic silt-clay of low plasticity	OL	0.01 – 0.04	0.033
Inorganic silts, fine sands or silty soils, elastic silts	MH	0.02 – 0.07	0.066
Inorganic clays of high plasticity, elastic soils	CH	0.00 – 0.05	0.047

**Notes:** [1] Default values should be adopted in absence of local site data. The default values have been developed from a statistical analysis of NSW soil data (Landcom, 2004) and represent the statistical average plus one standard deviation for each soil type.

### F3. Point score erosion hazard assessment system

The following erosion hazard assessment form is presented as an example. Regulatory authorities may choose to modify its contents and/or trigger value to better address local issues and conditions (e.g. within the catchment of sensitive receiving waters).

The **total score** is used to identify certain actions required by the proponent, or may simply be used to identify *low-risk* and *high-risk* sites. Within the attached form, a total score of 17 (default value) or greater may be considered *high-risk*.

The **trigger values** are used to identify issues of particular importance and to trigger specific actions required by the proponent, such as the submission of a preliminary ESCP during the planning phase of the development.



**Table F4 – Erosion hazard assessment form**

Condition	Points	Score	Trigger value
<b>AVERAGE SLOPE OF DISTURBANCE AREA [1]</b> <ul style="list-style-type: none"> <li>not more than 3% [3% <math>\approx</math> 33H:1V]</li> <li>more than 3% but not more than 5% [5% = 20H:1V]</li> <li>more than 5% but not more than 10% [10% = 10H:1V]</li> <li>more than 10% but not more than 15% [15% <math>\approx</math> 6.7H:1V]</li> <li>more than 15%</li> </ul>	0 1 2 4 6		4
<b>SOIL CLASSIFICATION GROUP (AS1726) [2]</b> <ul style="list-style-type: none"> <li>GW, GP, GM, GC</li> <li>SW, SP, OL, OH</li> <li>SM, SC, MH, CH</li> <li>ML, CL, or if <i>imported fill</i> is used, or if soils are untested</li> </ul>	0 1 2 3		
<b>EMERSON (DISPERSION) CLASS NUMBER [3]</b> <ul style="list-style-type: none"> <li>Class 4, 6, 7, or 8</li> <li>Class 5</li> <li>Class 3, (default value if soils are untested)</li> <li>Class 1 or 2</li> </ul>	0 2 4 6		6
<b>DURATION OF SOIL DISTURBANCE [4]</b> <ul style="list-style-type: none"> <li>not more than 1 month</li> <li>more than 1 month but not more than 4 months</li> <li>more than 4 months but not more than 6 months</li> <li>more than 6 months</li> </ul>	0 2 4 6		6
<b>AREA OF DISTURBANCE [5]</b> <ul style="list-style-type: none"> <li>not more than 1000 m<sup>2</sup></li> <li>more than 1000 m<sup>2</sup> but not more than 5000 m<sup>2</sup></li> <li>more than 5000 m<sup>2</sup> but not more than 1 ha</li> <li>more than 1 ha but not more than 4 ha</li> <li>more than 4 ha</li> </ul>	0 1 2 4 6		4
<b>WATERWAY DISTURBANCE [6]</b> <ul style="list-style-type: none"> <li>No disturbance to a watercourse, open drain or channel</li> <li>Involves disturbance to a constructed open drain or channel</li> <li>Involves disturbance to a natural watercourse</li> </ul>	0 1 2		2
<b>REHABILITATION METHOD [7]</b> Percentage of area (relative to total disturbance) revegetated by seeding without light mulching (i.e. worst-case revegetation method). <ul style="list-style-type: none"> <li>not more than 1%</li> <li>more than 1% but not more than 5%</li> <li>more than 5% but not more than 10%</li> <li>more than 10%</li> </ul>	0 1 2 4		
<b>RECEIVING WATERS [8]</b> <ul style="list-style-type: none"> <li>Saline waters only</li> <li>Freshwater body (e.g. creek or freshwater lake or river)</li> </ul>	0 2		
<b>SUBSOIL EXPOSURE [9]</b> <ul style="list-style-type: none"> <li>No subsoil exposure except of service trenches</li> <li>Subsoils are likely to be exposed</li> </ul>	0 2		
<b>EXTERNAL CATCHMENTS [10]</b> <ul style="list-style-type: none"> <li>No external catchment</li> <li>External catchment diverted around the soil disturbance</li> <li>External catchment not diverted around the soil disturbance</li> </ul>	0 1 2		
<b>ROAD CONSTRUCTION [11]</b> <ul style="list-style-type: none"> <li>No road construction</li> <li>Involves road construction works</li> </ul>	0 2		
<b>pH OF SOILS TO BE REVEGETATED [12]</b> <ul style="list-style-type: none"> <li>more than pH 5.5 but less than pH 8</li> <li>other pH values, or if soils are untested</li> </ul>	0 1		
<b>Total Score</b> <sup>[13]</sup>			

### Explanatory notes (Point Score system)

**Requirements:** Specific issues or actions required by the proponent.

**Warnings:** Issues that should be considered by the proponent.

**Comments:** General information relating to the topic.

[1] **REQUIREMENTS:**

For sites with an average slope of proposed land disturbance greater than 10%, a preliminary ESCP must be submitted to the regulatory authority for approval during planning negotiations.

Proponents must demonstrate that adequate erosion and sediment control measures can be implemented on-site to effectively protect downstream environmental values.

If site or financial constraints suggest that it is not reasonable or practicable for the prescribed water quality objectives to be achieved for the proposal, then the proponent must demonstrate that alternative designs or construction techniques (e.g. pole homes, suspended slab) cannot reasonably be implemented on the site.

**WARNINGS:**

Steep sites usually require more stringent drainage and erosion controls than flatter grade sites.

**COMMENTS:**

The steeper the land, the greater the need for adequate drainage controls to prevent soil and mulch from being washed from the site.

[2] **REQUIREMENTS:**

If the actual soil K-factor is known from soil testing, then the Score shall be determined from Table F5.

If a preliminary ESCP is required during planning negotiations, then it must be demonstrated that adequate space is available for the construction and operation of any major sediment traps, including the provision for any sediment basins and their associated embankments and spillways. It must also be demonstrated that all reasonable and practicable measures can be taken to divert the maximum quantity of sediment-laden runoff (up to the specified design storm) to these sediment traps throughout the construction phase and until the contributing catchment is adequately stabilised against erosion.

**WARNINGS:**

The higher the point score, the greater the need to protect the soil from raindrop impact and thus the greater the need for effective erosion control measures. A point score of 2 or greater will require a greater emphasis to be placed on revegetation techniques that do not expose the soil to direct rainfall contact during vegetation establishment, e.g. turfing and *Hydromulching*.

**COMMENTS:**

Table F6 provides an *indication* of soil conditions likely to be associated with a particular Soil group based on a statistical analysis of soil testing across NSW. This table provides only an initial estimate of the likely soil conditions.

The left-hand-side of the table provides an indication of the type of sediment basin that will be required (Type C, F or D). The right-hand-side of the table provides an indication of the likely erodibility of the soil based on the Revised Universal Soil Loss Equation (RUSLE) K-factor.

Table F7 provides some general comments on the erosion potential of the various soil groups.

**Table F5 – Score if soil K-factor is known**

	RUSLE soil erodibility K-factor			
	K < 0.02	0.02<K<0.04	0.04<K<0.06	K > 0.06
Score	0	1	2	3

**Table F6 – Statistical analysis of NSW soil data<sup>[1]</sup>**

Unified Soil Class System	Likely sediment basin classification (%)			Probable soil erodibility K-factor (%) <sup>[2]</sup>			
	Dry		Wet	Low	Moderate	High	Very High
	Type C	Type F	Type D	K < 0.02	0.02<K<0.04	0.04<K<0.06	K > 0.06
GM	30	58	12	12	51	26	12
GC	42	33	25	13	71	17	0
SW	40	48	12	49	39	12	0
SP	53	32	15	76	18	5	1
SM	21	67	12	26	48	25	1
SC	26	50	24	16	64	18	2
ML	5	63	32	4	35	45	16
CL	9	51	39	12	56	19	13
OL	2	80	18	34	61	5	1
MH	12	41	48	15	19	41	25
CH	5	44	51	39	43	11	7

Notes: [1] Analysis of soil data presented in Landcom (2004).

[2] Soil erodibility based on Revised Universal Soil Loss Equation (RUSLE) K-factor.

**Unified Soil Classification System (USCS)**

- GW Well graded gravels, gravel-sand mixtures, little or no fines
- GP Poorly graded gravels, gravel-sand mixture, little or no fines
- GM Silty gravels, poorly graded gravel-sand-silt mixtures
- GC Clayey gravels, poorly graded gravel-sand-clay mixtures
- SW Well graded sands, gravelly sands, little or no fines
- SP Poorly graded sands, gravelly sands, little or no fines
- SM Silty sands, poorly graded sand-silt mixtures
- SC Clayey sands, poorly graded sand-clay mixtures
- ML Inorganic silts & very fine sands, rock flour, silty or clayey fine sands with slight plasticity
- CL Inorganic clays, low-medium plasticity, gravelly clays, sandy clays, silty clays, lean clays
- OL Organic silts and organic silt-clays of low plasticity
- MH Inorganic silts, micaceous or diatomaceous fine sandy or silty soils, elastic silts
- CH Inorganic clays of high plasticity, fat clays
- OH Organic clays of medium to high plasticity

**Table F7 – Typical properties of various soil groups <sup>[1]</sup>**

Soil Groups	Typical properties <sup>[2]</sup>
GW, GP	<ul style="list-style-type: none"> <li>• Low erodibility potential.</li> </ul>
GM, GC	<ul style="list-style-type: none"> <li>• Low to medium erodibility potential.</li> <li>• May create turbid runoff if disturbed as a result of the release of silt and clay particles.</li> </ul>
SW, SP	<ul style="list-style-type: none"> <li>• Low to medium erodibility potential.</li> </ul>
SM, SC	<ul style="list-style-type: none"> <li>• Medium erodibility potential.</li> <li>• May create turbid runoff if disturbed as a result of the release of silt and clay particles.</li> </ul>
MH, CH	<ul style="list-style-type: none"> <li>• Highly variable (low to high) erodibility potential.</li> <li>• Will generally create turbid runoff if disturbed.</li> </ul>
ML, CL	<ul style="list-style-type: none"> <li>• High erodibility potential.</li> <li>• Tendency to be dispersive.</li> <li>• May create some turbidity in runoff if disturbed.</li> </ul>

Note: [1] After Soil Services & NSW DLWC (1998).

[2] Any soil can represent a high erosion risk if the binding clays or silts are unstable.

Table F8 provides **general** guidelines on the suitability of various soil groups to various engineering applications.

**Table F8 – Engineering suitability based on Unified Soil Classification <sup>[1]</sup>**

Unified Soil Class	USC Group	Embankments		Fill	Slope stability	Untreated roads
		Water retaining	Non water retaining			
Well graded gravels	GW	Unsuitable	Excellent	Excellent	Excellent	Average
Poorly graded gravel	GP	Unsuitable	Average	Excellent	Average	Unsuitable
Silty gravels	GM	Unsuitable	Average	Good	Average	Average
Clayey gravels	GC	Suitable	Average	Good	Average	Excellent
Well graded sands	SW	Unsuitable	Excellent	Excellent	Excellent	Average
Poorly graded sands	SP	Unsuitable	Average	Good	Average	Unsuitable
Silty sands	SM	Suitable <sup>[2]</sup>	Average	Average	Average	Poor
Clayey sands	SC	Suitable	Average	Average	Average	Good
Inorganic silts	ML	Unsuitable	Poor	Average	Poor	Unsuitable
Inorganic clays	CL	Suitable <sup>[2]</sup>	Good	Average	Good	Poor
Organic silts	OL	Unsuitable	Unsuitable	Poor	Unsuitable	Unsuitable
Inorganic silts	MH	Unsuitable	Poor	Poor	Poor	Unsuitable
Inorganic clays	CH	Suitable <sup>[2]</sup>	Average	Unsuitable	Average	Unsuitable
Organic clays	OH	Unsuitable	Unsuitable	Unsuitable	Unsuitable	Unsuitable
Highly organic soils	PT	Unsuitable	Unsuitable	Unsuitable	Unsuitable	Unsuitable

Notes: [1] Modified from Hazelton & Murphy (1992)

[2] Suitable only after modifications to soil such as compaction and/or erosion protection



- [3] If the soils have not been tested for Emerson Class, then adopt a score of 4.

**REQUIREMENTS:**

Works proposed on sites containing Emerson Class 1 or 2 soils have a very high pollution potential and must submit a conceptual ESCP to the regulatory authority for review and/or approval (as required by the authority) during planning negotiations.

**WARNINGS:**

Class 3 and 5 soils disturbed by cut and fill operations or construction traffic are highly likely to discolour stormwater (i.e. cause turbid runoff). Chemical stabilisation will likely be required if these soils are placed immediately adjacent to a retaining wall. Any disturbed Class 1, 2, 3 and 5 soils that are to be revegetated must be covered with a non-dispersive topsoil as soon as possible (unless otherwise agreed by the regulatory authority).

Class 1 and 2 soils are highly likely to discolour (pollute) stormwater if exposed to rainfall or flowing water. Treatment of these soils with gypsum (or other suitable substance) will most likely be required. These soils should not be placed directly behind a retaining wall unless it has been adequately treated (stabilised) or covered with a non-dispersible soil.

- [4] The duration of disturbance refers to the total duration of soil exposure to rainfall up until a time when there is at least 70% coverage of all areas of soil.

**REQUIREMENTS:**

All land developments with an expected soil disturbance period greater than 6 months must submit a conceptual ESCP to the regulatory authority for review and/or approval (as required by the authority) during planning negotiations.

**COMMENTS:**

Construction periods greater than 3 months will generally experience at least some significant storm events, independent of the time of year that the construction (soil disturbance) occurs.

- [5] **REQUIREMENTS:**

Development proposals with an expected soil disturbance in excess of 1ha must submit a conceptual ESCP to the regulatory authority for review and/or approval (as required by the regulatory authority) during planning negotiations.

The area of disturbance refers to the total area of soil exposed to rainfall or dust-producing winds either as a result of:

- (a) the removal of ground cover vegetation, mulch or sealed surfaces;
- (b) past land management practices;
- (c) natural conditions.

**WARNINGS:**

A *Sediment Basin* will usually be required if the disturbed area exceeds 0.25ha (2500m<sup>2</sup>) within any sub-catchment (i.e. land flowing to one outlet point).

**COMMENTS:**

For soil disturbances greater than 0.25ha, the revegetation phase should be staged to minimise the duration for which soils are exposed to wind, rain and concentrated runoff.

**[6] REQUIREMENTS:**

All developments that involve earthworks or construction within a natural watercourse (whether that watercourse is in a natural or modified condition) must submit a conceptual ESCP to the regulatory authority for review and/or approval (as required by the regulatory authority) during planning negotiations.

Permits and/or licences may be required from the State Government, including possible submission of the ESCP to the relevant Government department.

**COMMENTS:**

The management of works within a natural watercourse is discussed in Appendix I – *Instream works*.

**[7] REQUIREMENTS:**

No areas of soil disturbance shall be left exposed to rainfall or dust-producing winds at the end of a development without an adequate degree of protection and/or an appropriate action plan for the establishment of at least 70% cover.

**COMMENTS:**

Grass seeding without the application of a light mulch cover is considered the least favourable revegetation technique. A light mulch cover is required to protect the soil from raindrop impact, excessive temperature fluctuations, and the loss of essential soil moisture.

**[8] COMMENTS:**

All receiving waters can be adversely affected by unnatural quantities of sediment-laden runoff. Freshwater ecosystems are generally more susceptible to ecological harm resulting from the inflow of fine or dispersible clays than saline water bodies. The further inland a land disturbance is, the greater the potential for the released sediment to cause environmental harm as this sediment travels towards the coast.

For the purpose of this clause it is assumed that all sediment-laden runoff will eventually flow into saline waters. Thus, sediment-laden discharges that flow first into freshwater are likely to adversely affect both fresh and saline water bodies and are therefore considered potentially more damaging to the environment.

This clause does **not** imply that sediment-laden runoff will not cause harm to saline waters.

**[9] COMMENTS:**

This clause refers to subsoils exposed during the construction phase either as a result of past land practices or proposed construction activities. The exposure of subsoils resulting from the excavation of minor service trenches should not be considered.

**[10] WARNINGS:**

The greater the extent of external catchment, the greater the need to divert up-slope stormwater runoff around any soil disturbance.

**COMMENTS:**

The ability to separate "clean" (i.e. external catchment) stormwater runoff from "dirty" site runoff can have a significant effect on the size, efficiency and cost of the temporary drainage, erosion, and sediment control measures.

**[11] REQUIREMENTS:**

Permission must be obtained from the owner of a road reserve before placing any erosion and sediment control measures within the road reserve.

**WARNINGS:**

Few sediment control techniques work efficiently when placed on a road and/or around roadside stormwater inlets. Great care must be taken if sediment control measures are located on a public roadway, specifically:

- safety issues relating to road users;
- the risk of causing flooding on the road or within private property.

The construction of roads (whether temporary or permanent) will usually modify the flow path of stormwater runoff. This can affect how “dirty” site runoff is directed to the sediment control measures.

**COMMENTS:**

“On-road” sediment control devices are at best viewed as secondary or supplementary sediment control measures. Only in special cases and/or on very small projects (e.g. kerb and channel replacement) might these controls be considered as the “primary” sediment control measure.

**[12] WARNINGS:**

Soils with a pH less than 5.5 or greater than 8 will usually require treatment in order to achieve satisfactory revegetation. Soils with a pH of less than 5 (whether naturally acidic or in acid sulfate soil areas) may also limit the choice of chemical flocculants (e.g. Alum) for use in the flocculation of *Sediment Basins*.

**[13] REQUIREMENTS:**

A preliminary ESCP must be submitted to the local government for approval during the planning phase for any development that obtains a total point score of 17 or greater or when any trigger value is scored or exceeded.

---

## DRAIN AND SEDIMENT DAM SIZING

**Table 0.1** Indicative diversion drain sizing

Name	Catchment area (km <sup>2</sup> )	Length (m)	Bed width (m)	Top width (m)	Bed Slope (%)	Batter slopes
Drainage diversion 2	1.1	1,396	10.0	30.0	0.5	1v:3h
Drainage diversion 3	5.7	298	10.0	30.0	0.8	1v:3h

---



**Table 0.2 Sediment dam sizing**

Storage name	Active stage	Latitude	Longitude	Max. catchment area (ha)	Total volume required (ML)	Dam surface area (ha)	5-day dewatering rate (ML/d)	Sediment dam water source	Receiving waters description
SD9	S1-S3	-22.3432	148.2276	19.0	4.2	0.19	0.56	East Creek Out of pit spoil	Drainage line 7
SD10	S1-S3	-22.3469	148.2239	15.8	3.5	0.15	0.46	East Creek Out of pit spoil	Drainage line 7
SD11	S1-S3	-22.3378	148.2192	32.6	7.1	0.32	0.95	East Creek in pit spoil	Drainage line 6
SD12	S1-S3	-22.3419	148.2297	23.3	5.1	0.23	0.68	East Creek in pit spoil	Drainage line 7
SD13	S1-S3	-22.3353	148.2226	10.5	2.3	0.10	0.31	East Creek in pit spoil	Drainage line 6
SD14	S1-S3	-22.3341	148.2203	15.9	3.5	0.16	0.47	East Creek in pit spoil	Drainage line 6
SD15	S1-S3	-22.3315	148.2156	18.1	4.0	0.18	0.53	East Creek Out of pit spoil	Drainage line 5
SD16	S1-S3	-22.3640	148.2363	9.4	2.1	0.09	0.27	Hughes Creek Out of pit spoil	Hughes Creek
SD17	S1-S3	-22.3578	148.2441	43.7	9.6	0.43	1.28	Hughes Creek In pit spoil	Hughes Creek
SD18	S1-S3	-22.3612	148.2469	105.0	23.0	1.02	3.07	Hughes Creek In pit spoil	Hughes Creek
SD19	S2-S3	-22.3737	148.2492	10.3	2.3	0.10	0.30	Hughes Creek In pit spoil	Hughes Creek
SD20	S3	-22.3682	148.2531	12.7	2.8	0.12	0.37	Hughes Creek In pit spoil	Hughes Creek
SD21	S3	-22.3737	148.2581	22.6	5.0	0.22	0.66	Hughes Creek In pit spoil	Hughes Creek
SD22	S3	-22.3782	148.2617	34.5	7.6	0.34	1.01	Hughes Creek In pit spoil	Hughes Creek
SD23	S3	-22.3784	148.2570	5.8	1.3	0.06	0.17	Hughes Creek In pit spoil	Hughes Creek

SD24	S3	-22.3852	148.2657	8.5	1.9	0.08	0.25	Hughes Creek In pit spoil	Hughes Creek
SD25	S3	-22.3875	148.2673	39.5	8.7	0.38	1.15	Hughes Creek In pit spoil	Hughes Creek
SD26	S3	-22.3888	148.2675	9.4	2.1	0.09	0.27	Hughes Creek In pit spoil	Hughes Creek
SD27	S3	-22.3914	148.2635	15.5	3.4	0.15	0.45	Hughes Creek Out of pit spoil	Hughes Creek
SD28	S3	-22.4011	148.2697	32.4	7.1	0.32	0.95	Hughes Creek Out of pit spoil	Barrett Creek
SD29	S3	-22.3944	148.2710	15.5	3.4	0.15	0.45	Hughes Creek In pit spoil	Hughes Creek
SD30	S3	-22.3818	148.2641	1.1	0.2	0.01	0.03	Hughes Creek In pit spoil	Hughes Creek
HWD1	S1	-22.2866	148.1497	10.0	2.2	0.1	0.29	Highwall Trail Area bench	Drainage line 2

\* Dam depths and surface areas are concept sizes only and to be confirmed during detailed design.

**SITE-SPECIFIC ESC INSPECTION TEMPLATE**

<i>ESCP Inspection Proforma</i>			
<u>Date:</u>	<u>Time:</u>	<u>Name/Department:</u>	
<u>Reiter ID:</u>	<u>Mining Area:</u>	<u>Description:</u>	<u>Type:</u>
<u>Previous Inspection Date</u>		<u>Previous Report :</u>	
<u>Does the Catchment drain off lease?</u>		No	
<u>Outstanding actions</u>			<u>Action</u>
<u>ESCP controls</u>	<u>Condition at inspection</u>	<u>Action</u>	
Drain		Yes	
Drain		Yes	
Dam Spillway		Yes	
Rehab Slope		Yes	
Drain		Yes	
<u>Action Number</u>	<u>Actions required</u>	<u>Time Frame</u>	
1		Before Next Inspection	
2		Before Wet Season	
3		ASAP	
4			
5			
6			
7			
8			
<u>ASAP Action Assianment</u>			
<u>Person/s Responsible</u>	<u>SAP EHSM</u>	<u>Due Date</u>	
<u>Additional Controls required in compliance with ESCP</u>			
<u>Location of controls</u>	<u>Comments</u>		
	•		
	•		
	•		
	•		
	•		
	•		
	•		
<u>Action required to allow catchment to drain off lease in compliance with ESCP</u>			
•			
•			
•			
•			
•			
•			
<u>OTHER COMMENTS</u>			
•			
•			
•			
•			
•			
•			

<p><u>Feature Diagram</u></p>
<p><u>Inspection Photo/s</u></p>

Figure 0.1 Example ESC inspection template





Level 1, 369 Ann Street Brisbane  
PO Box 10703 Brisbane Adelaide Street Qld 4000  
**07 3225 0200**

Level 5, 93 Mitchell Street Darwin  
GPO Box 43348 Casuarina NT 0811  
**08 8911 0060**

[wrm@wrmwater.com.au](mailto:wrm@wrmwater.com.au)  
[wrmwater.com.au](http://wrmwater.com.au)

ABN 96 107 404 544